

is for Apple

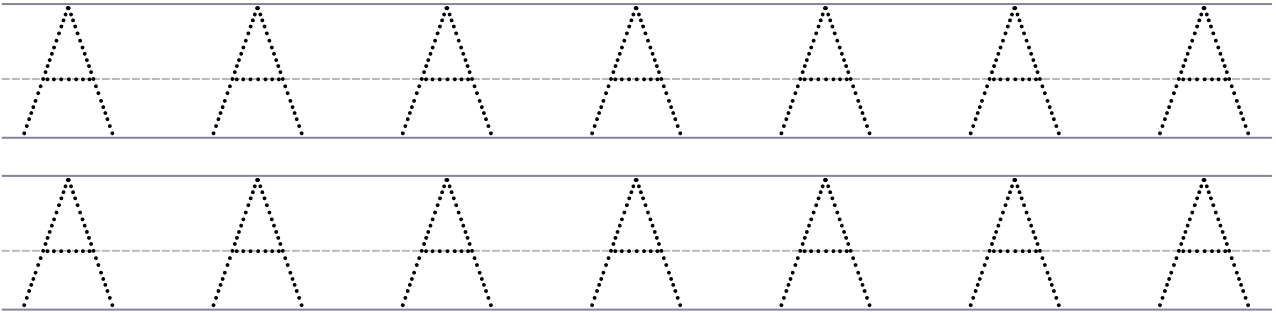

Trace the uppercase letters.



Trace the lowercase letters.

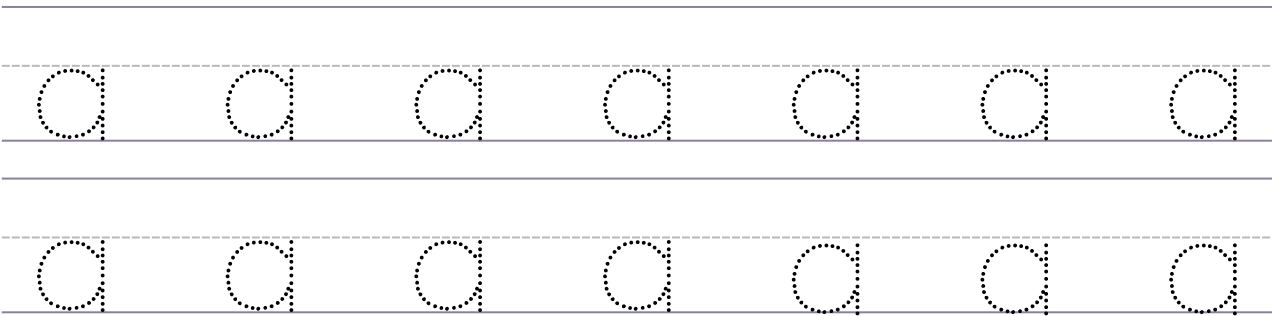

Circle the letter A & a.

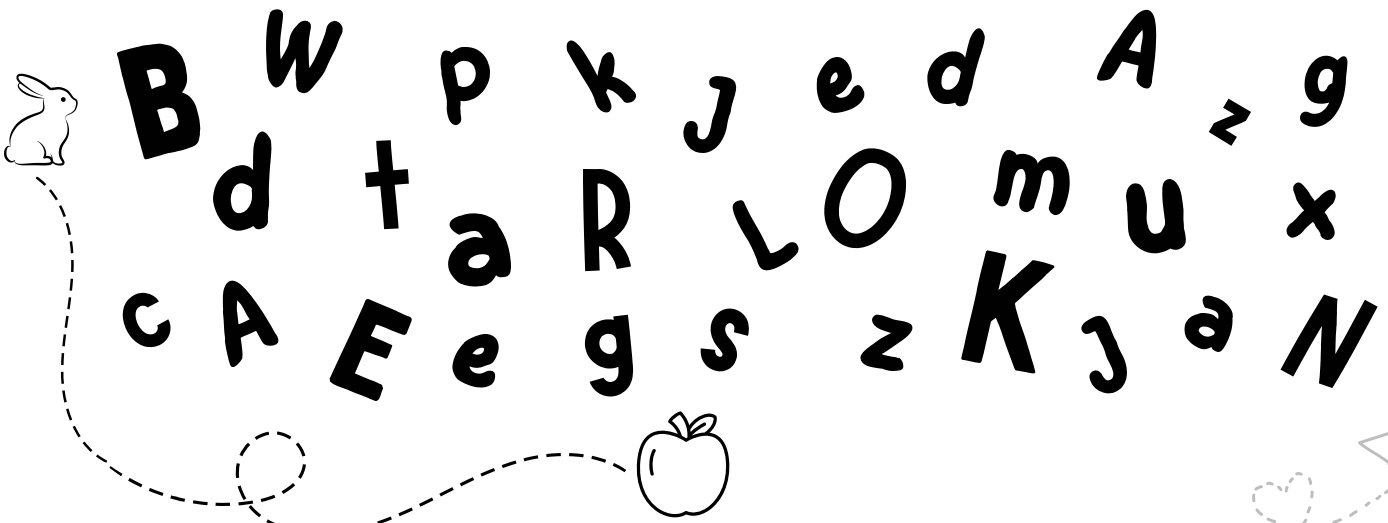

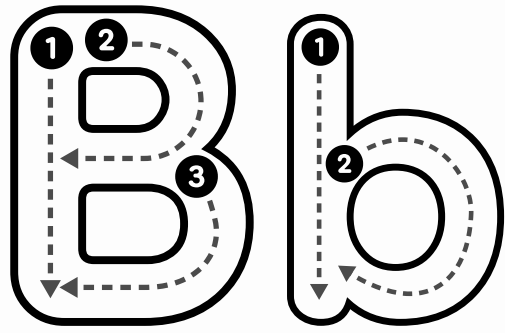
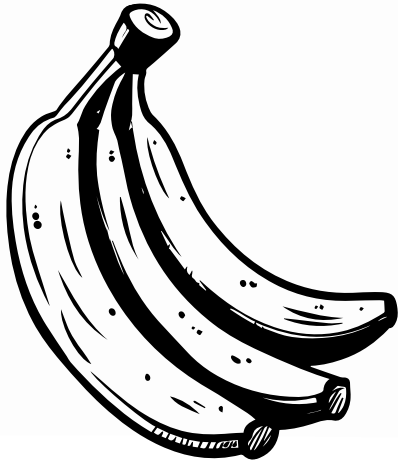

is for Banana



Trace the uppercase letters.

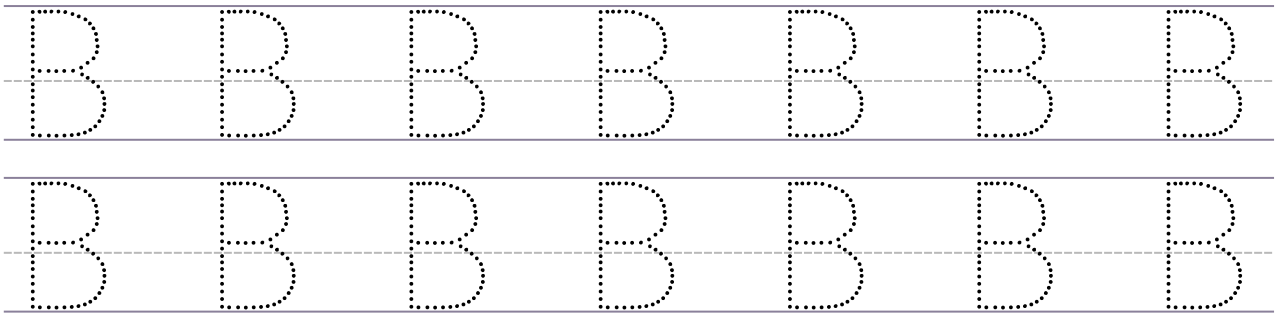

Trace the lowercase letters.

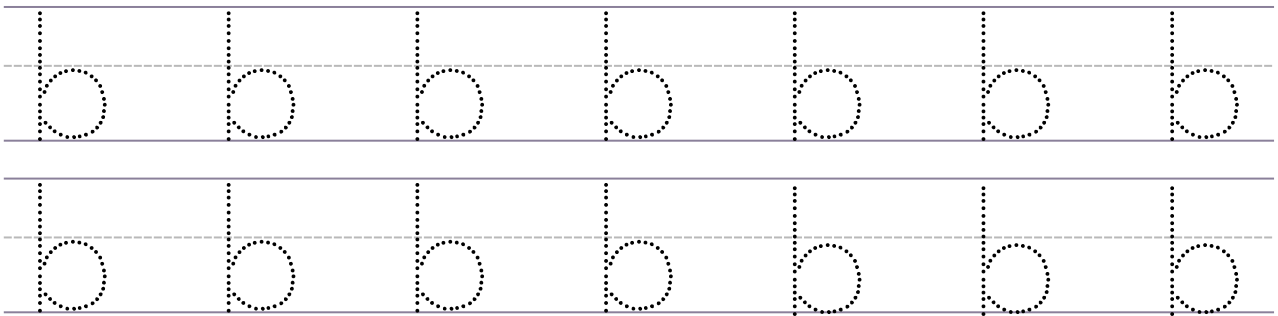

Circle the letter B & b

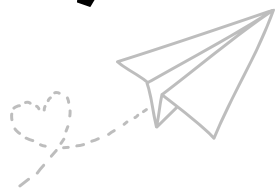
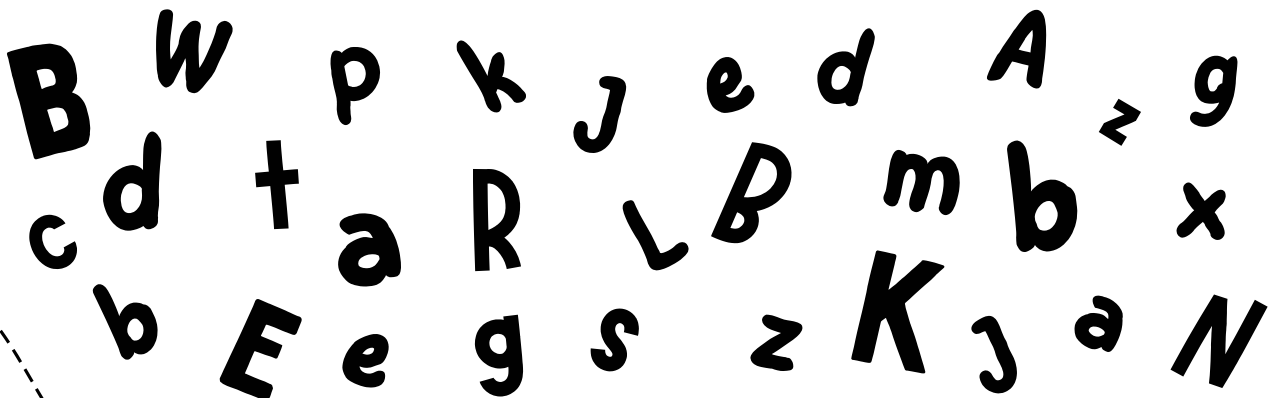

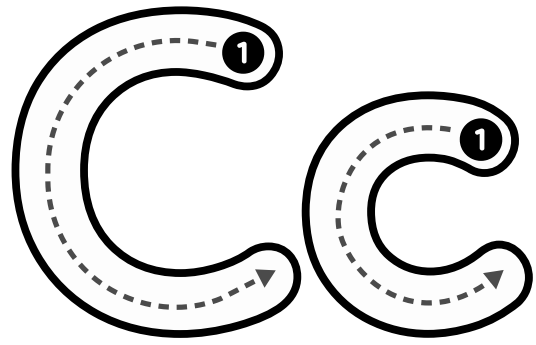
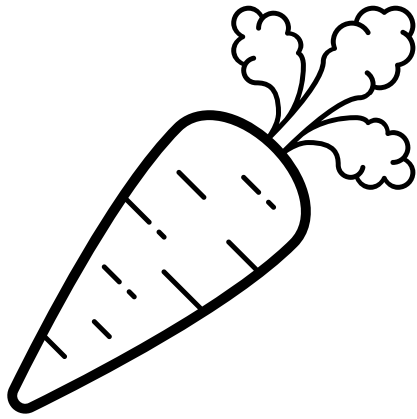

is for Carrot



Trace the uppercase letters.

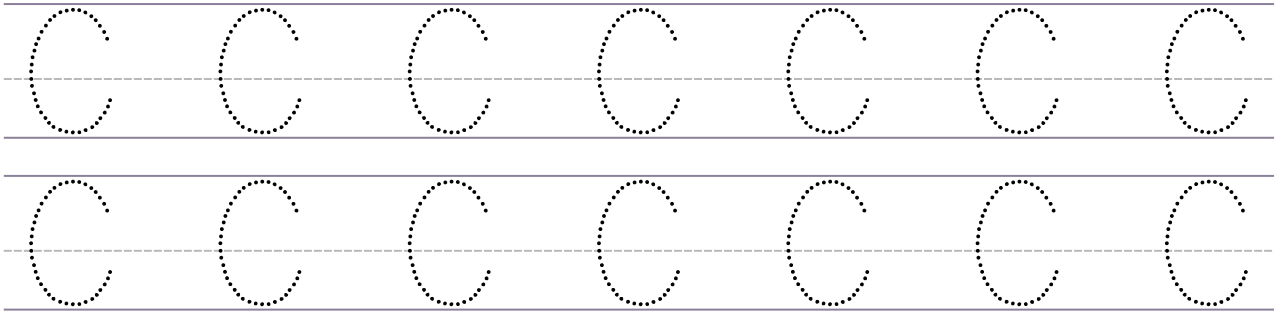

Trace the lowercase letters.

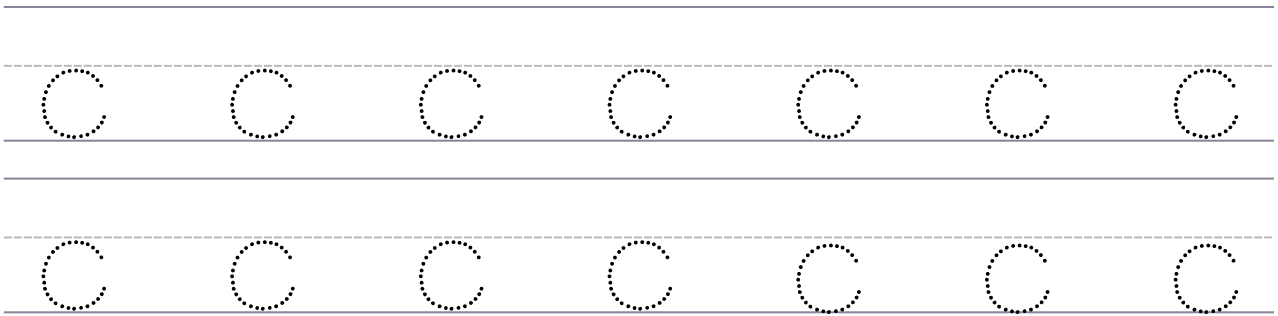

Circle the letter C & c

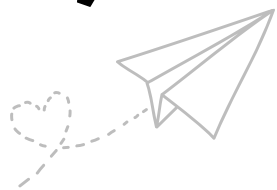
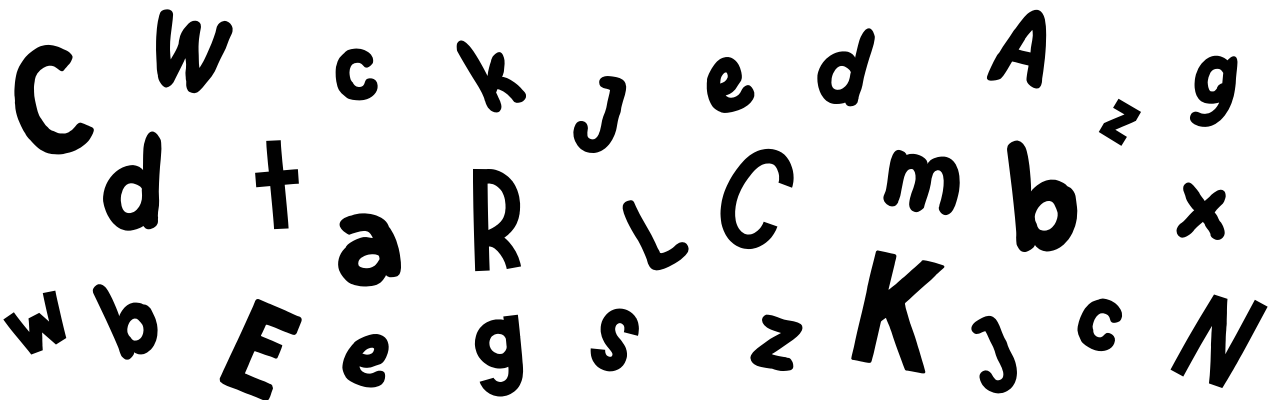

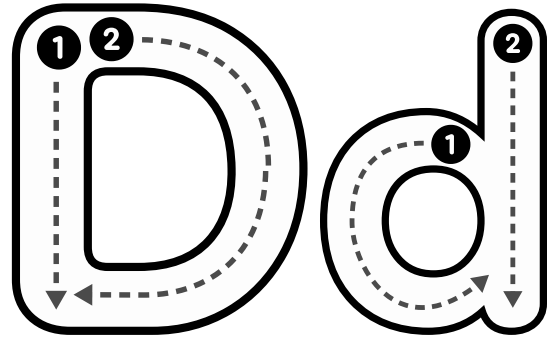
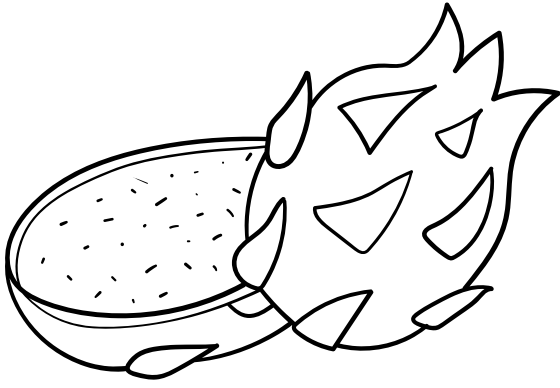

is for Dragonfruit



Trace the uppercase letters.

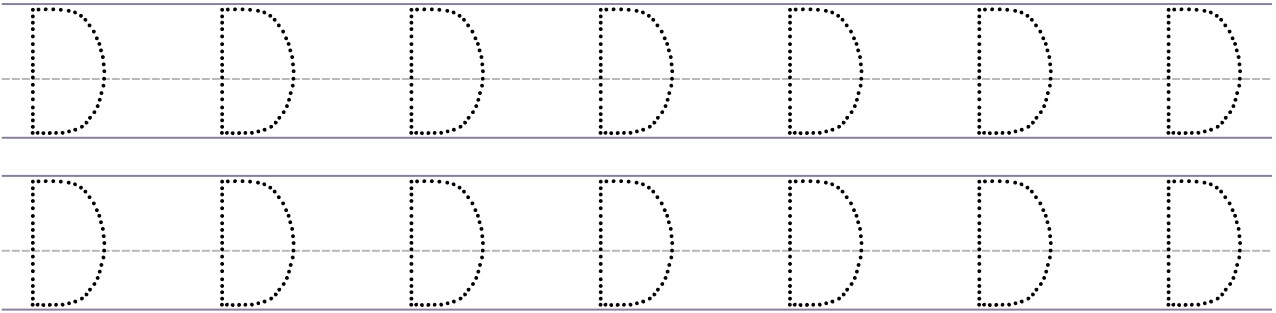

Trace the lowercase letters.

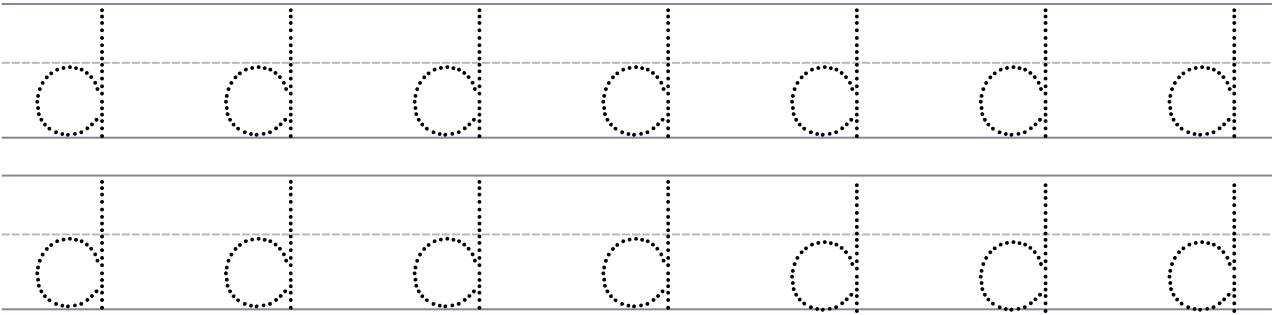

Circle the letter D & d

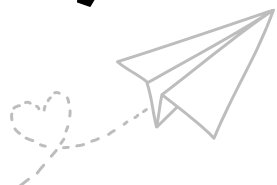
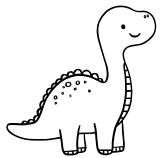
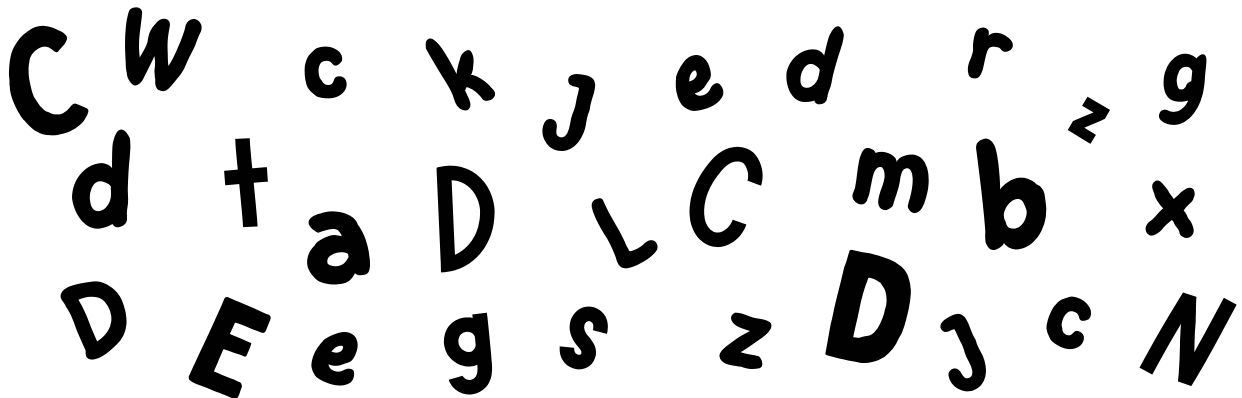

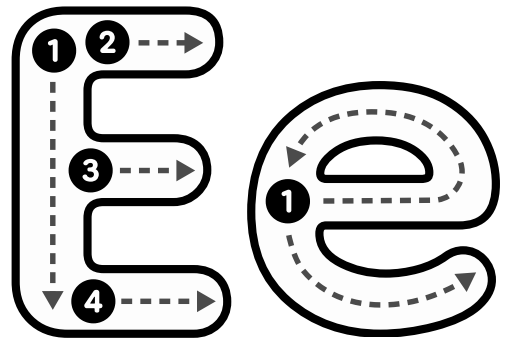
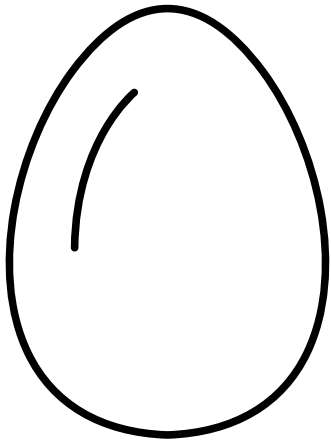

is for Egg



Trace the uppercase letters.

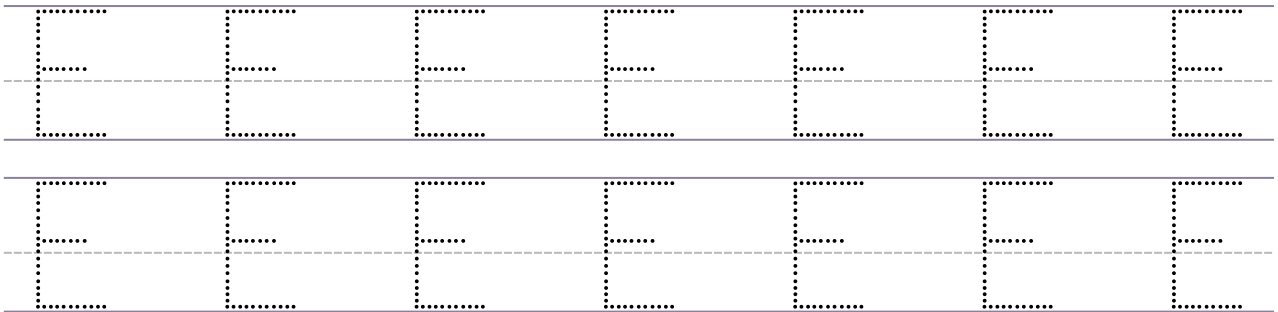

Trace the lowercase letters.

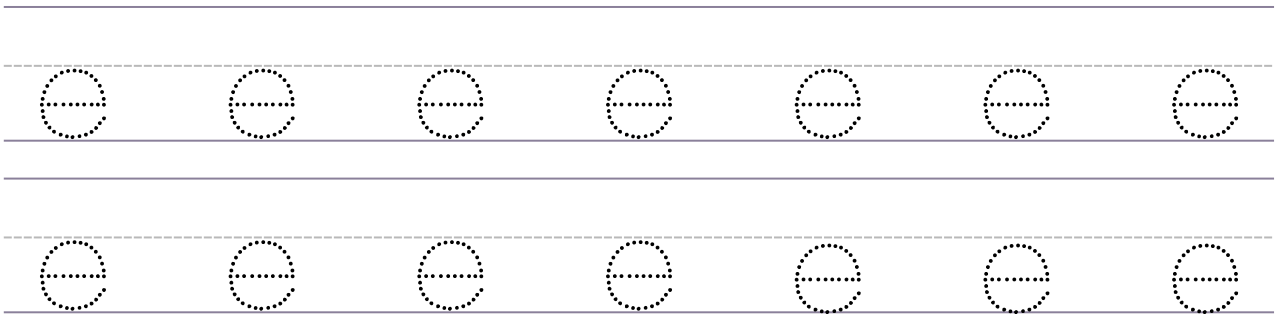

Circle the letter E & e

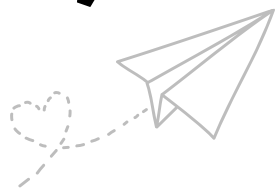
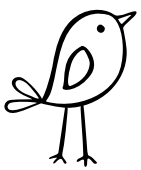
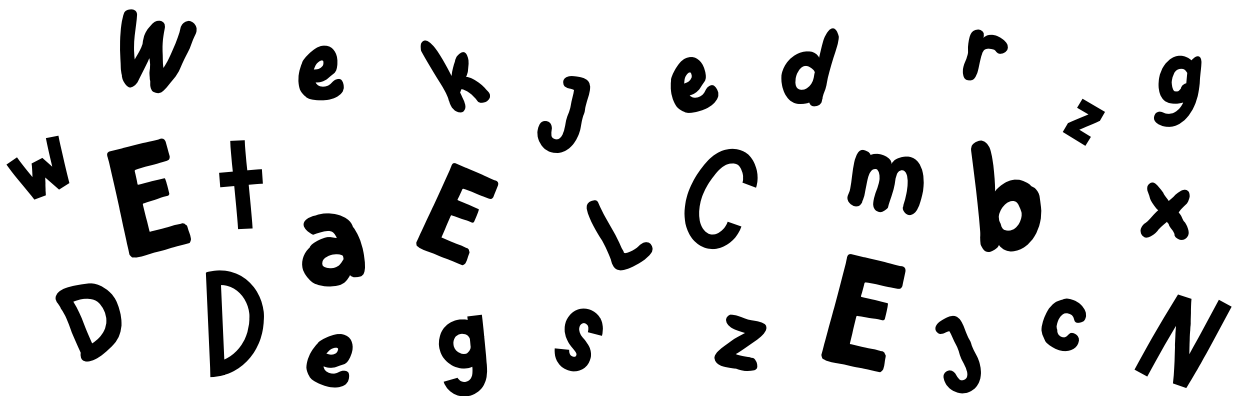

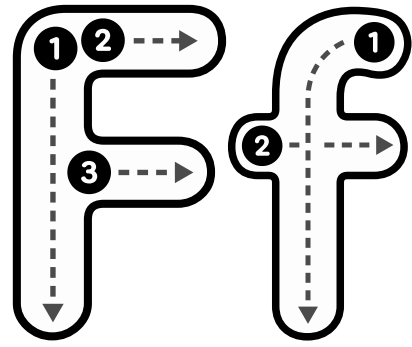
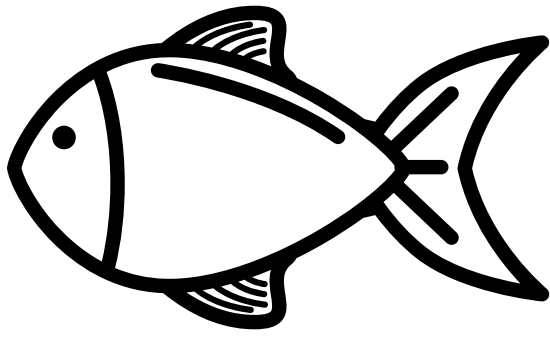

is for Fish



Trace the uppercase letters.

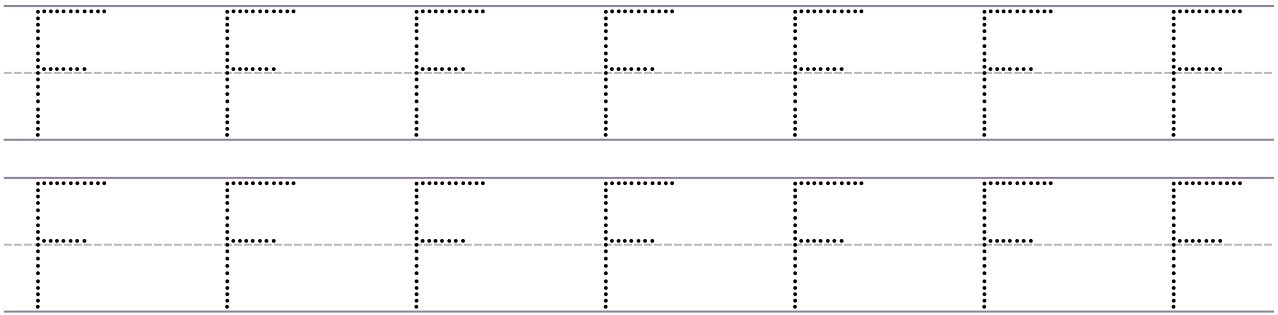

Trace the lowercase letters.

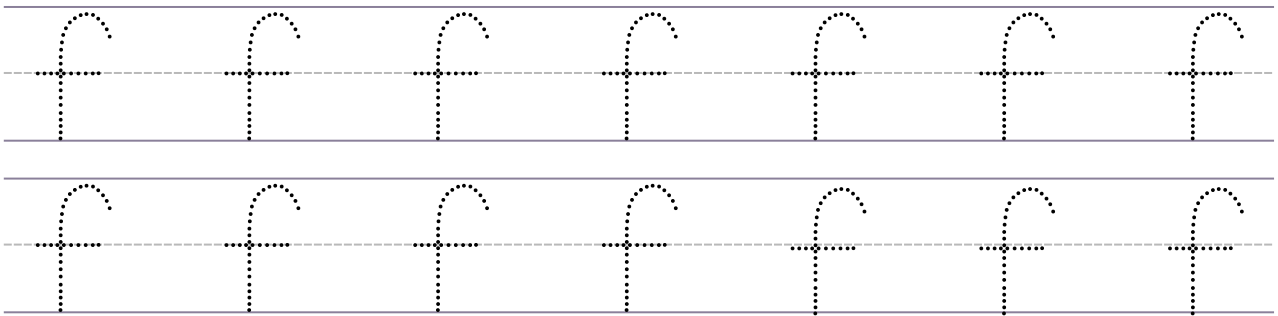

Circle the letter F & f.

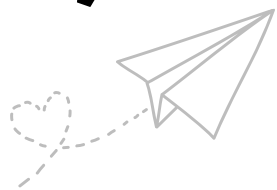
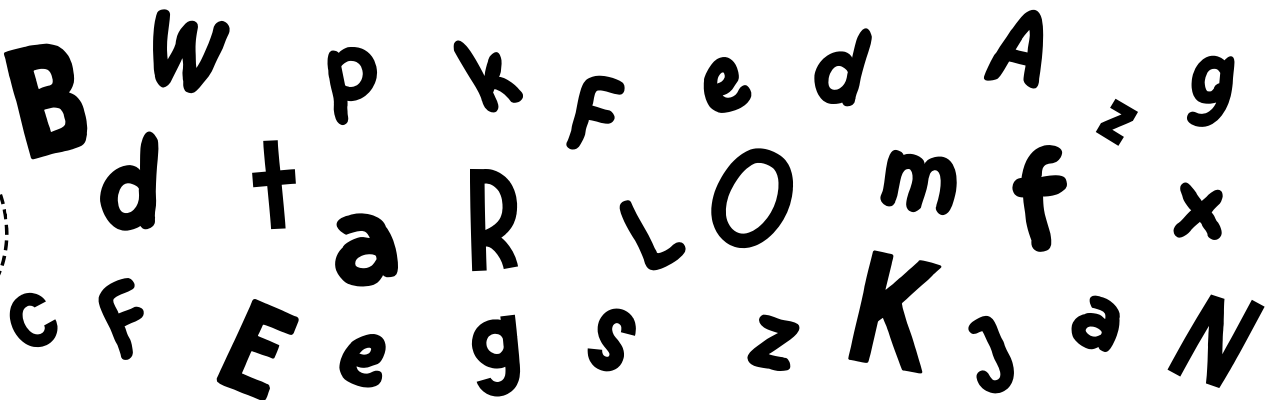

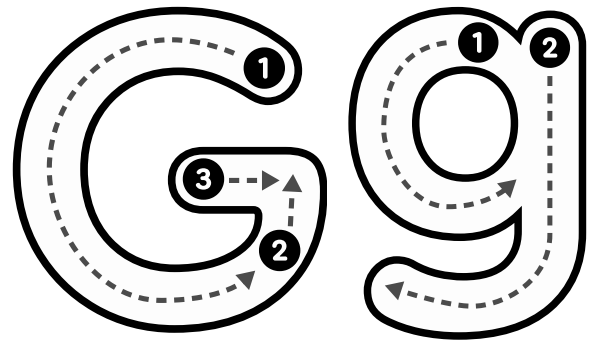
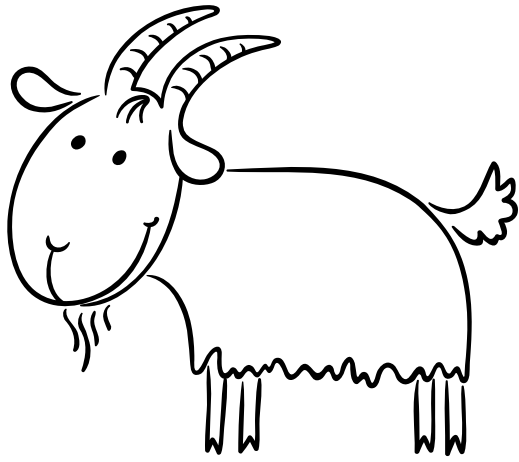

is for Goat



Trace the uppercase letters.

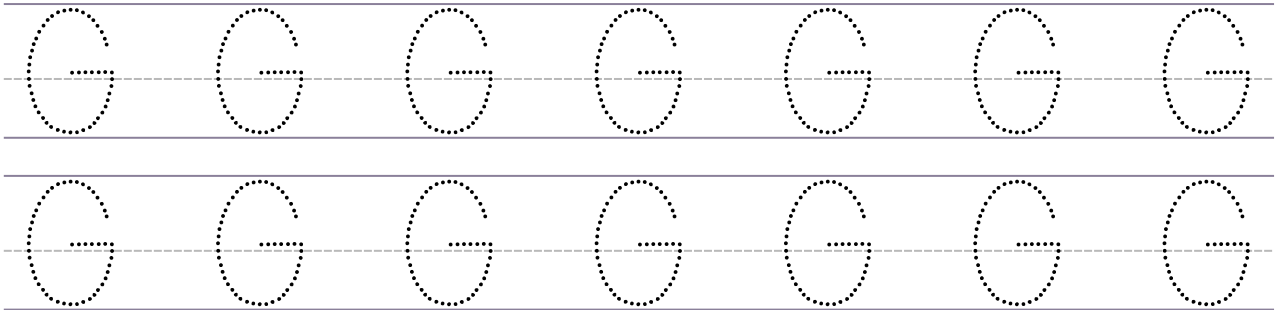

Trace the lowercase letters.

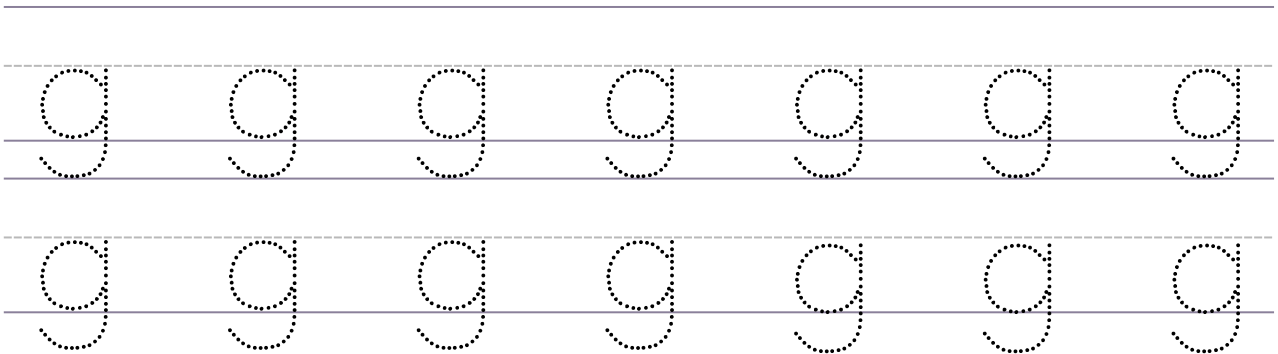

Circle the letter G & g.

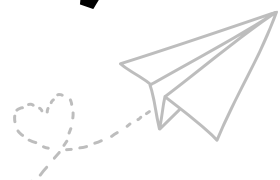
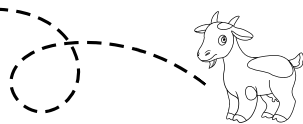
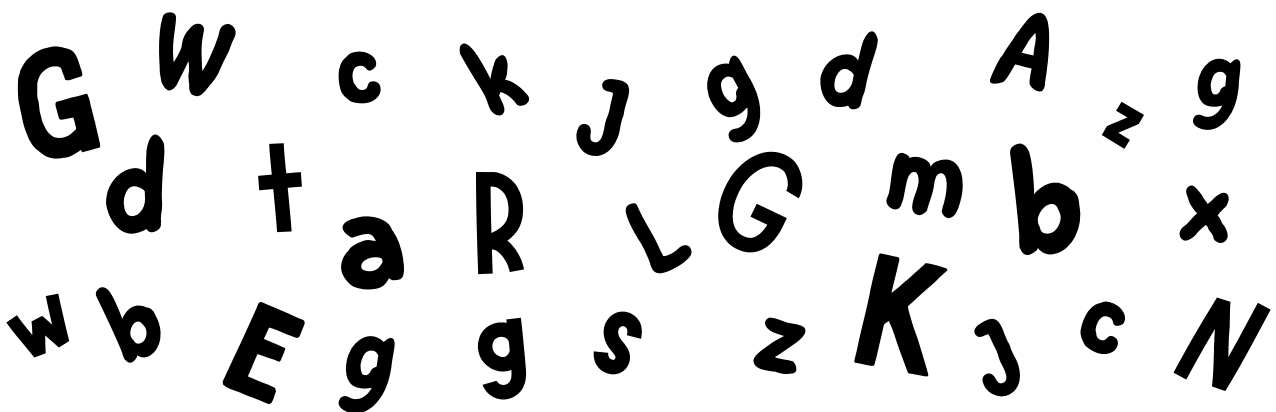

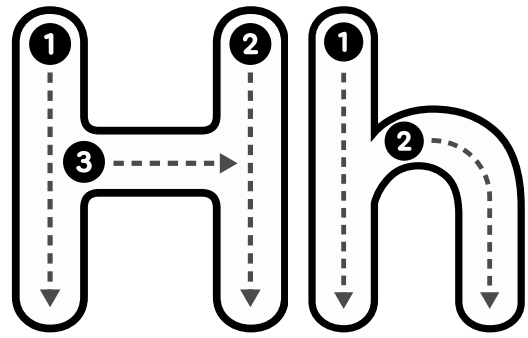
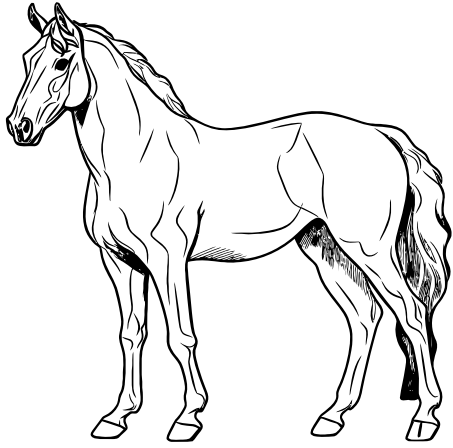

is for Horse



Trace the uppercase letters.



Trace the lowercase letters.

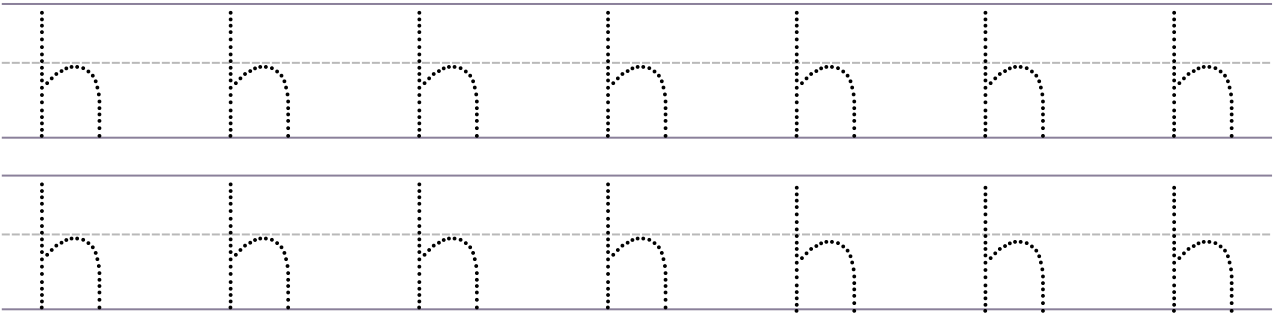

Circle the letter H & h.

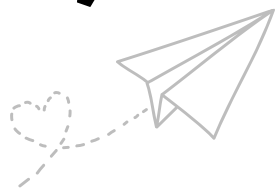
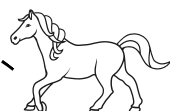
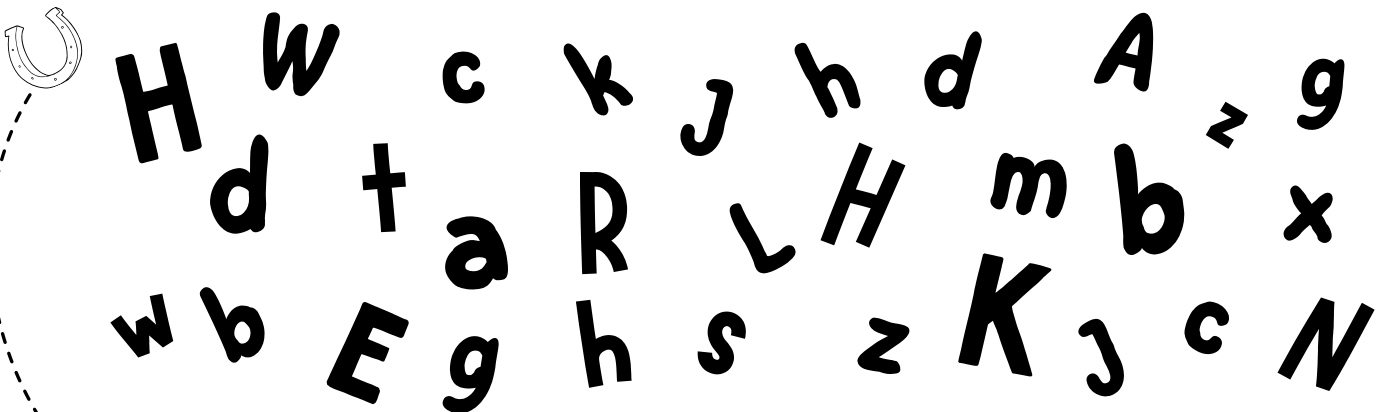

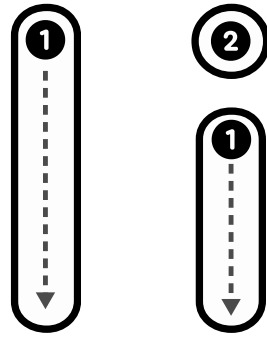

i is for Ink



Trace the uppercase letters.



Two sets of handwriting lines for tracing uppercase letters. Each set consists of a solid top line, a dashed middle line, and a solid bottom line. Vertical dotted lines are placed between the lines to form columns for tracing.



Trace the lowercase letters.



Two sets of handwriting lines for tracing lowercase letters. Each set consists of a solid top line, a dashed middle line, and a solid bottom line. Vertical dotted lines are placed between the lines to form columns for tracing.

Circle the letter I & i.

I W p k j e d A z i
d t a I L O m u x
c A F e g s i K j a N

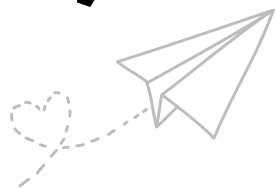

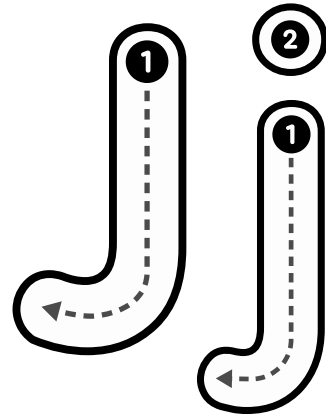

is for Jug



Trace the uppercase letters.

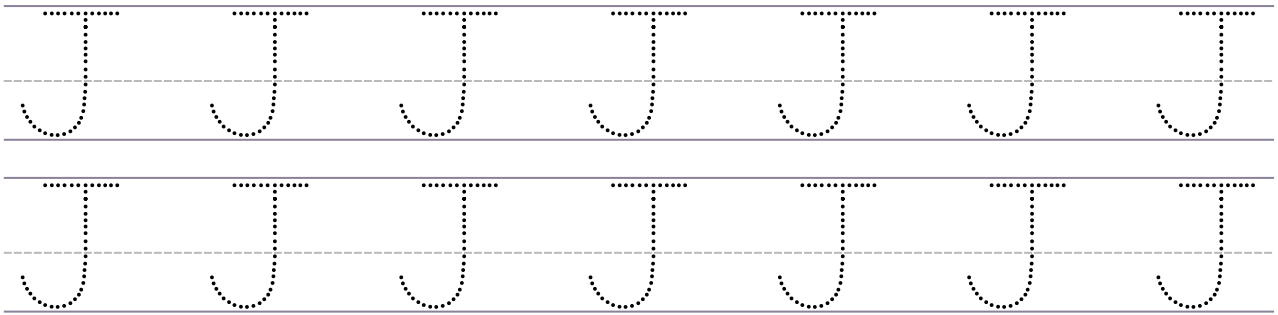

Trace the lowercase letters.

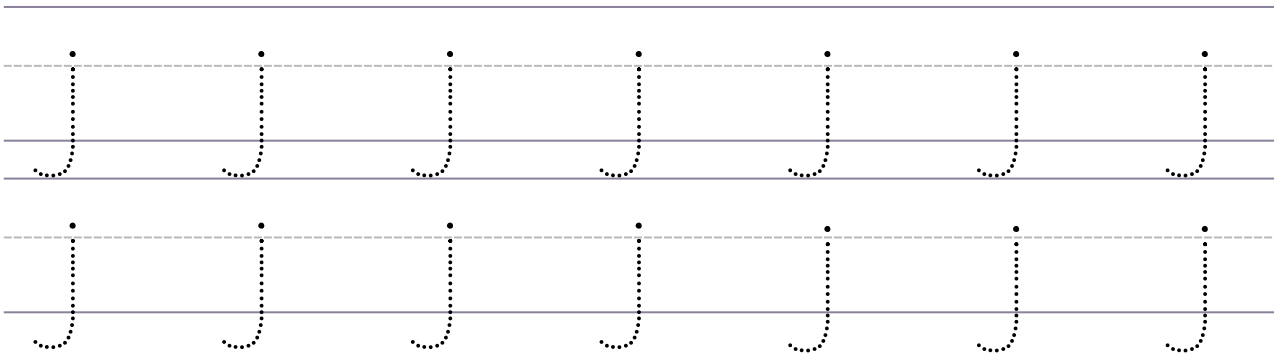

Circle the letter J & j.

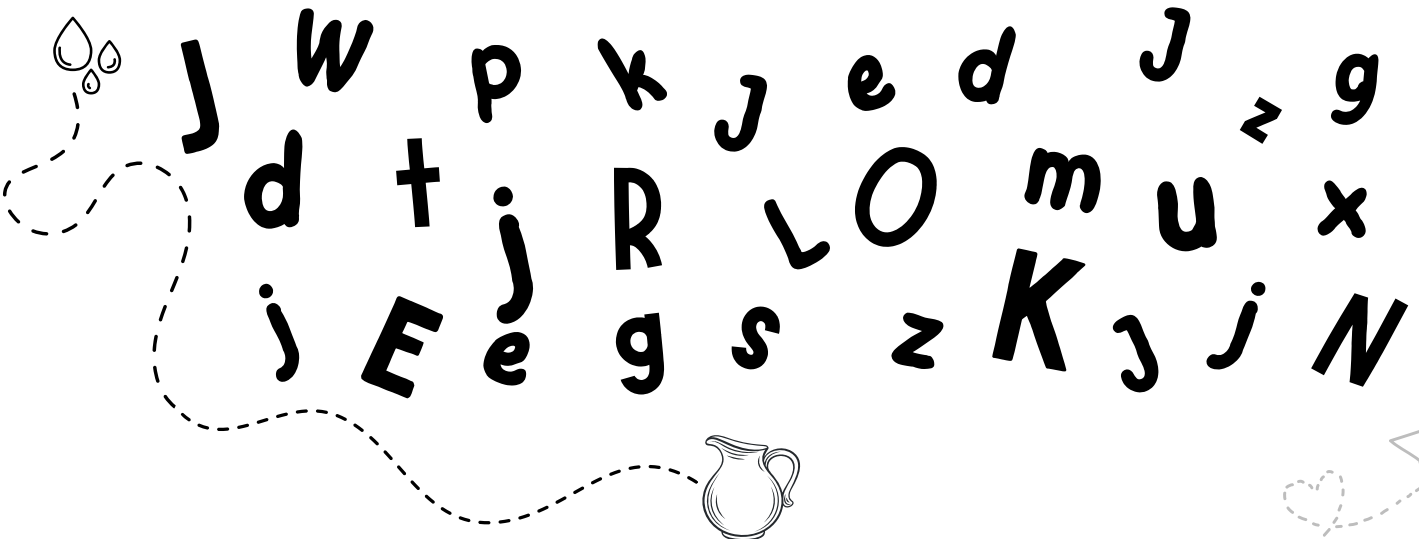

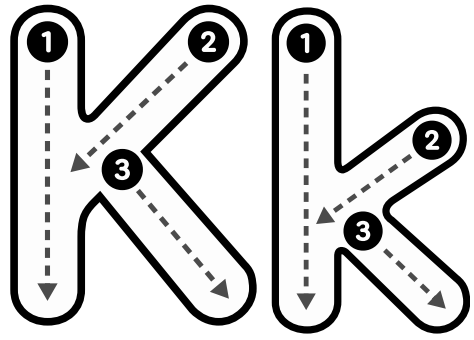
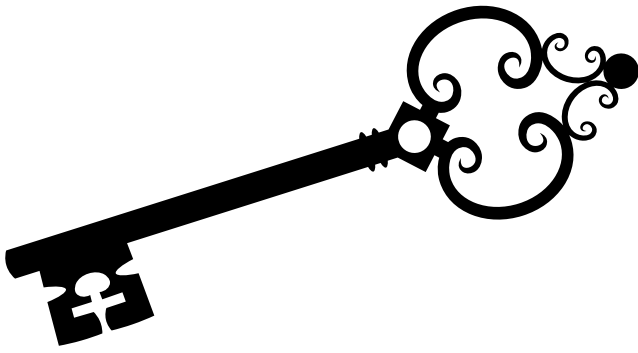

is for Key



Trace the uppercase letters.



Trace the lowercase letters.

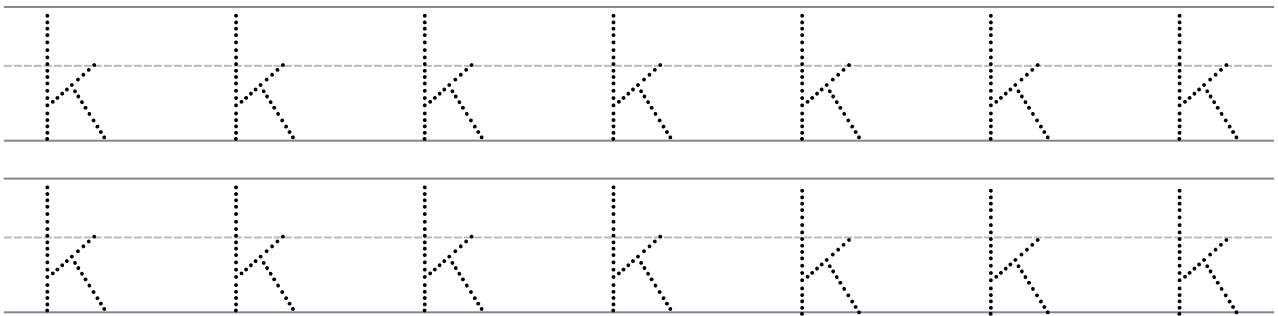

Circle the letter K & k.

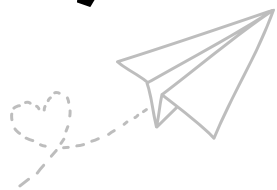
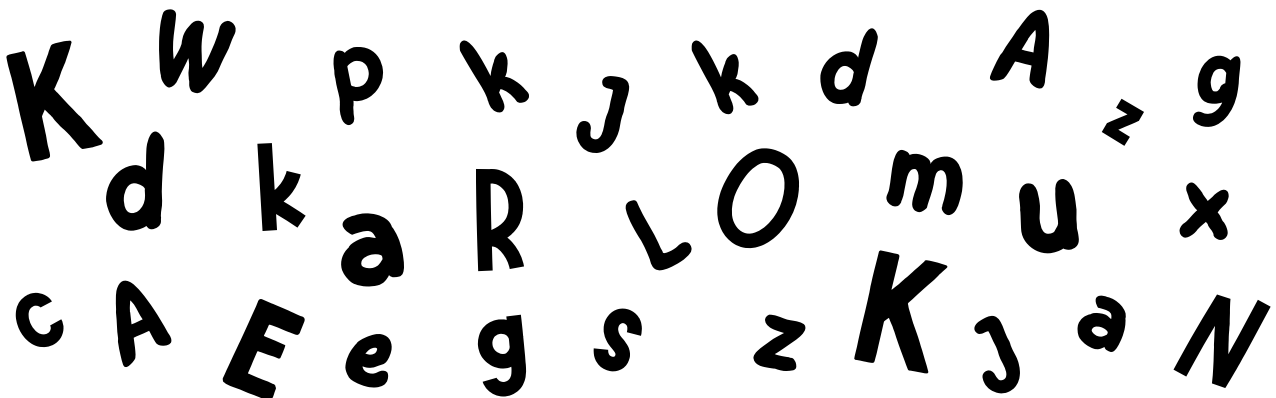

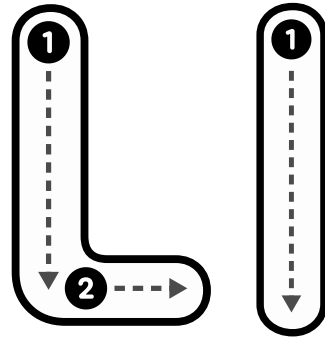
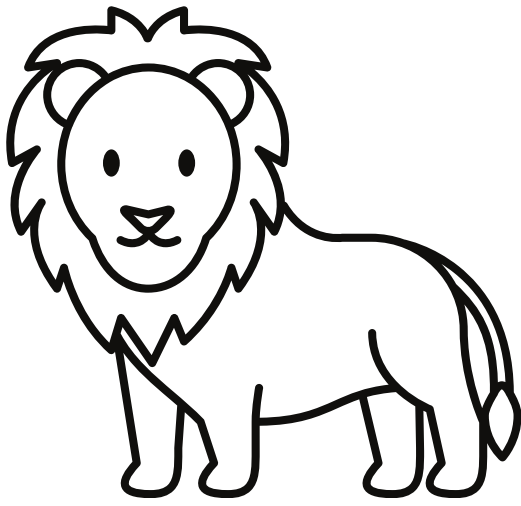

is for Lion



Trace the uppercase letters.

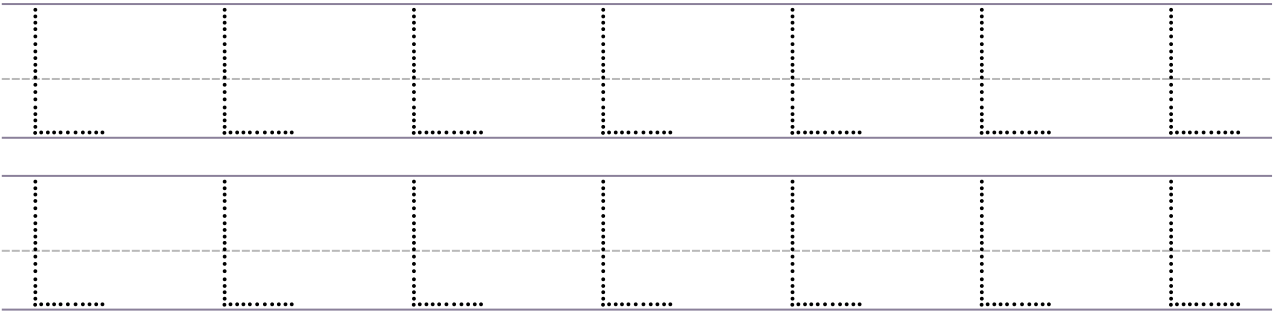

Trace the lowercase letters.

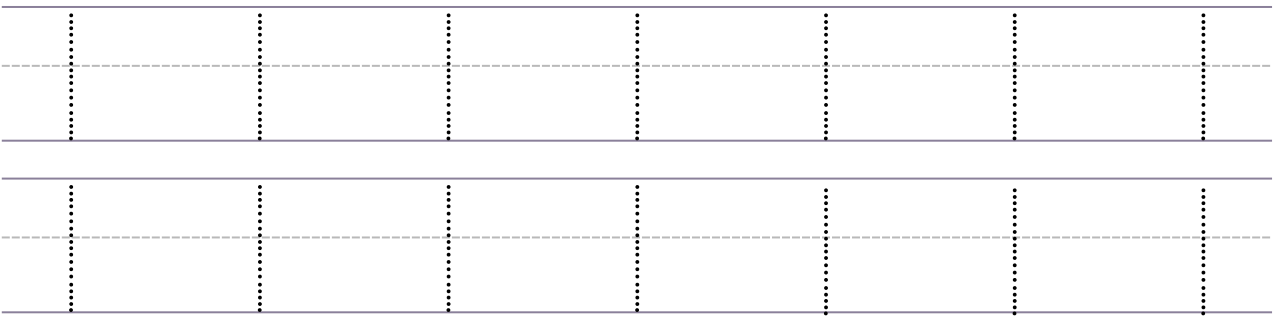

Circle the letter L & l.

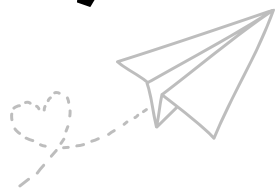
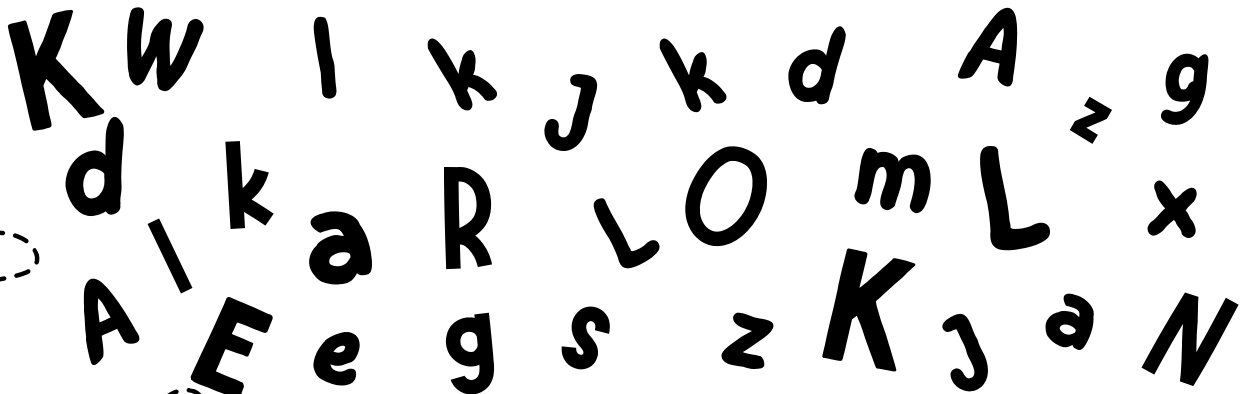

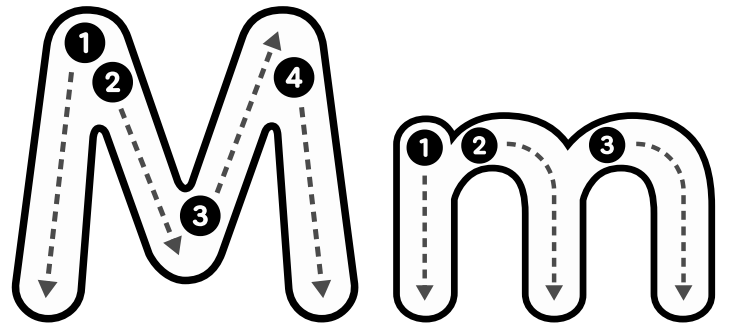
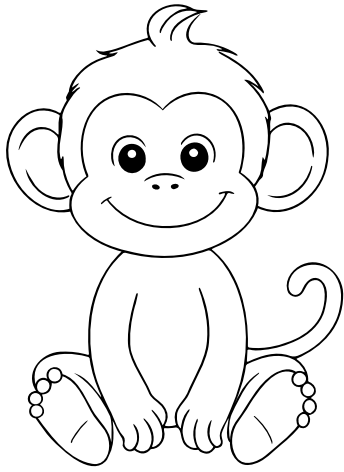

is for Monkey



Trace the uppercase letters.

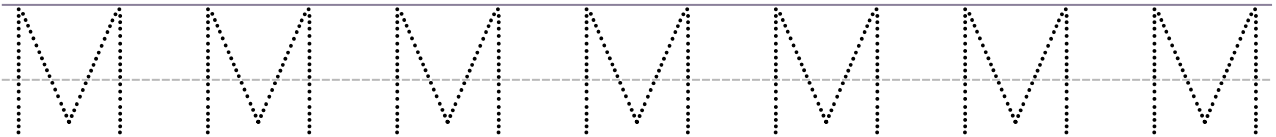
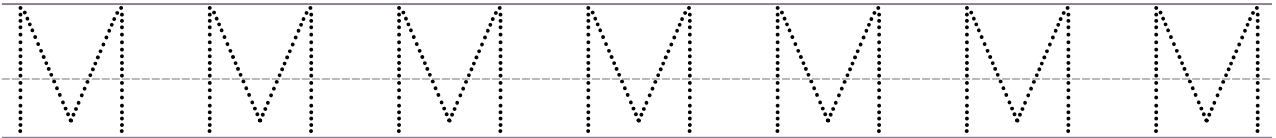

Trace the lowercase letters.



Circle the letter M & m.

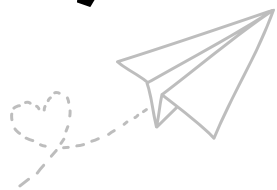
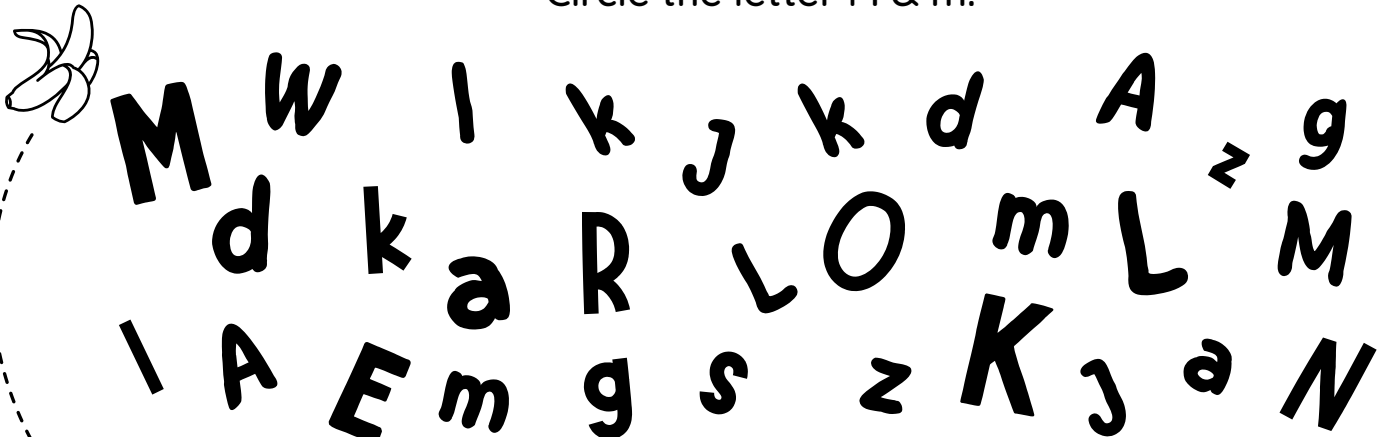

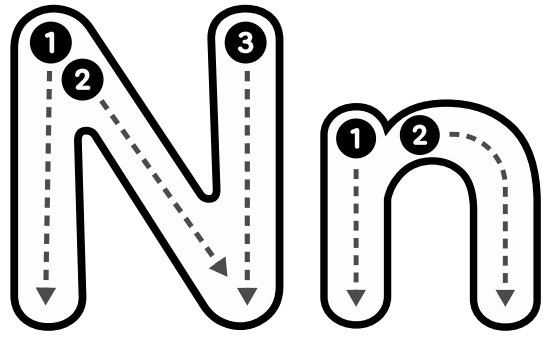

is for Nest



Trace the uppercase letters.

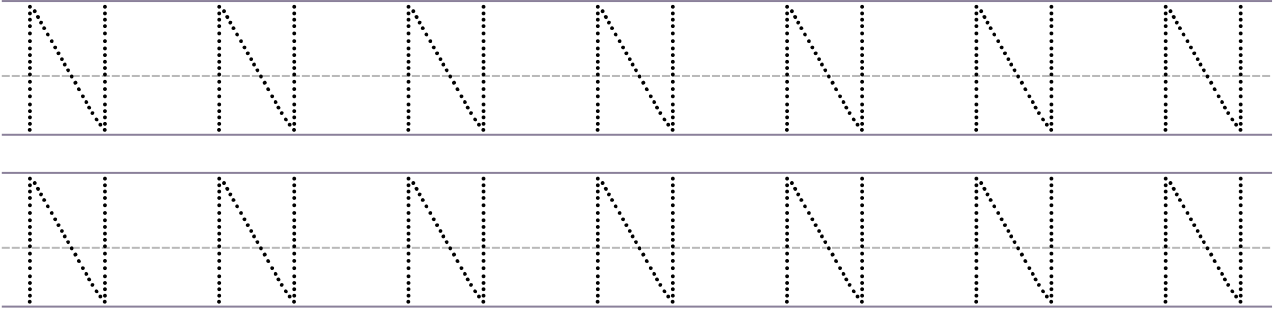

Trace the lowercase letters.

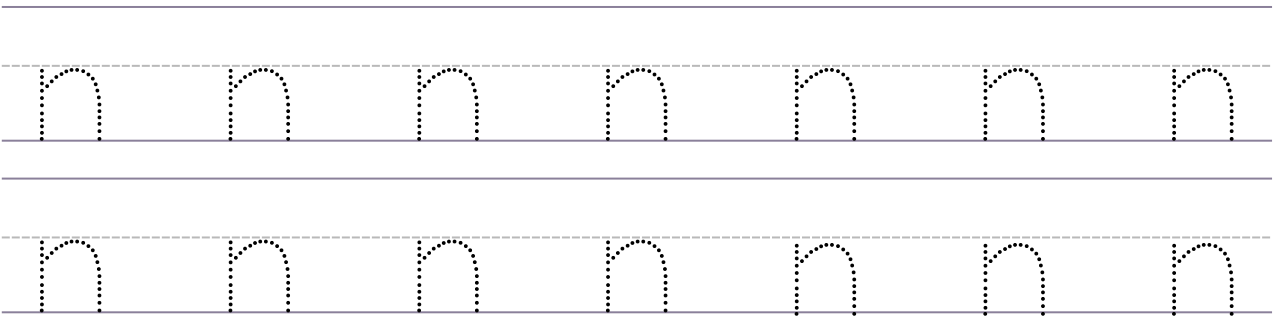

Circle the letter N & n.

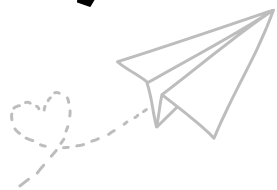
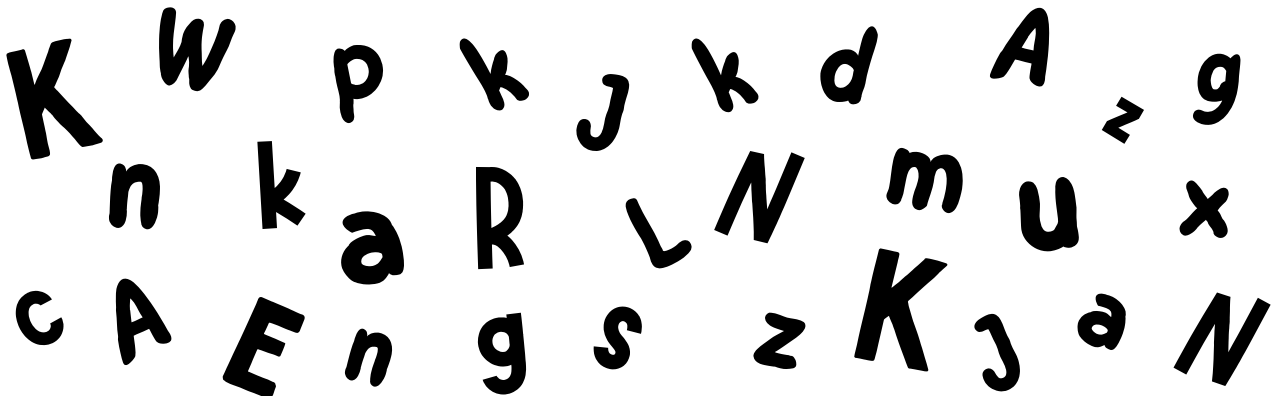

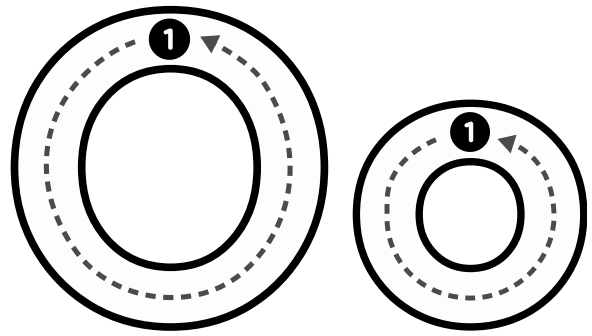
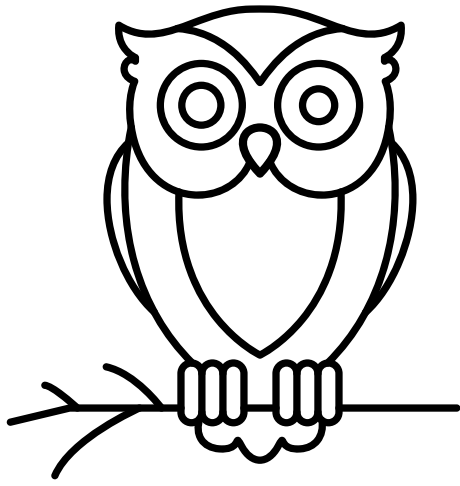

is for Owl



Trace the uppercase letters.

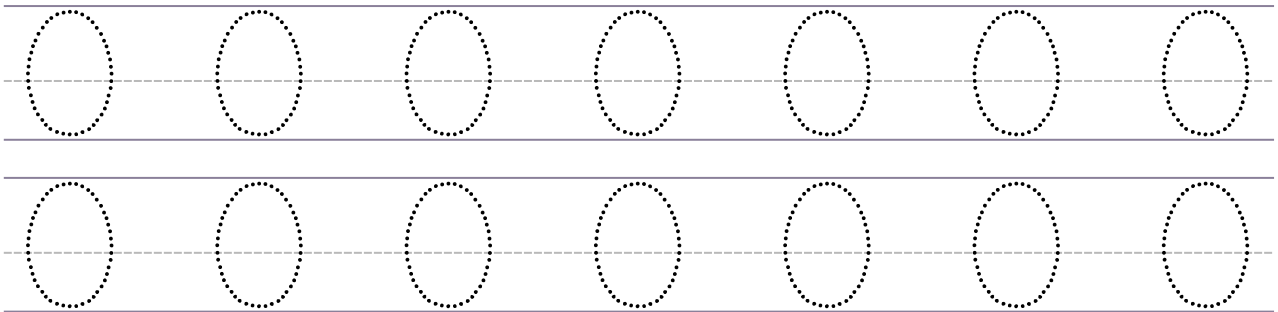

Trace the lowercase letters.

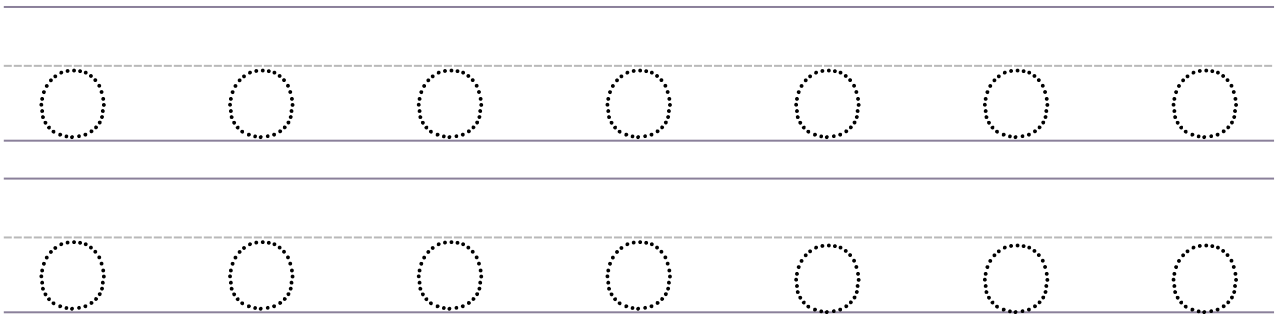

Circle the letter O & o.

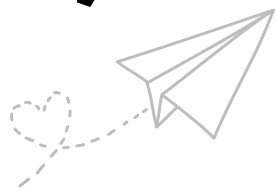
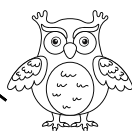
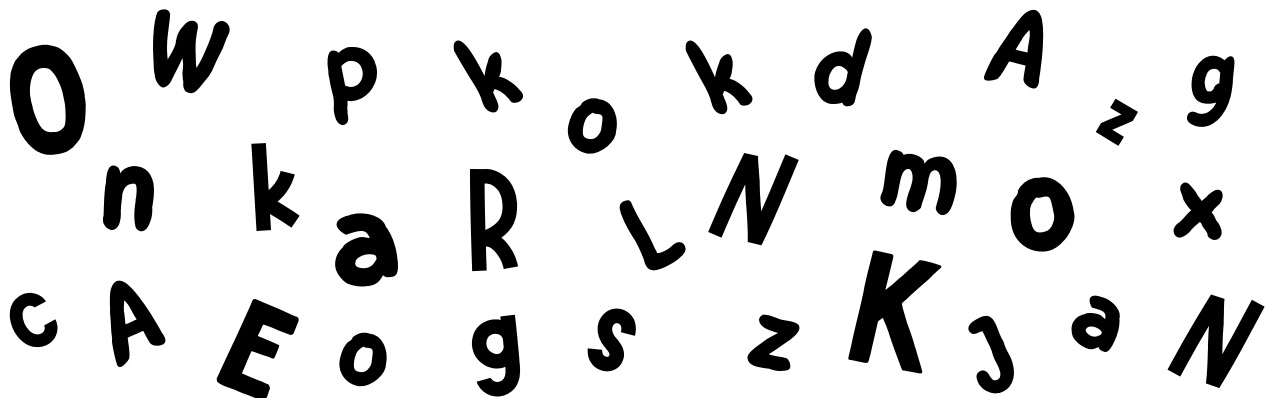

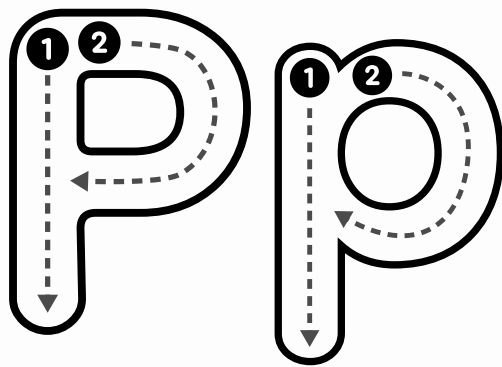

is for Panda



Trace the uppercase letters.

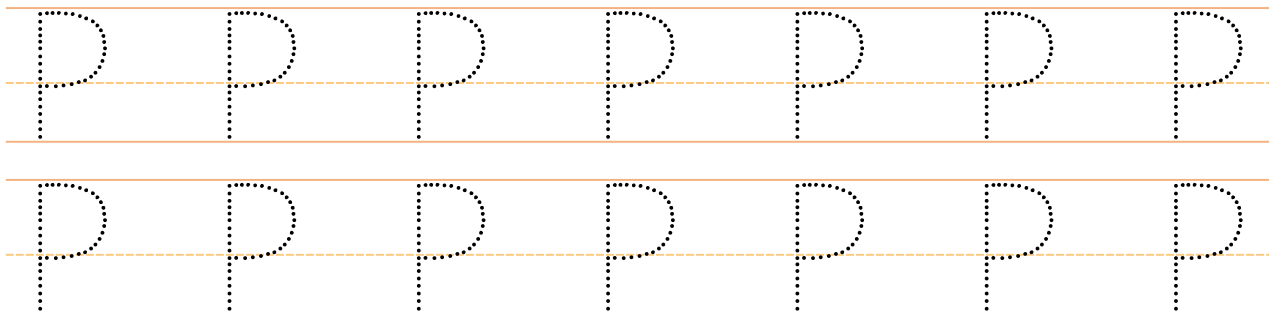

Trace the lowercase letters.

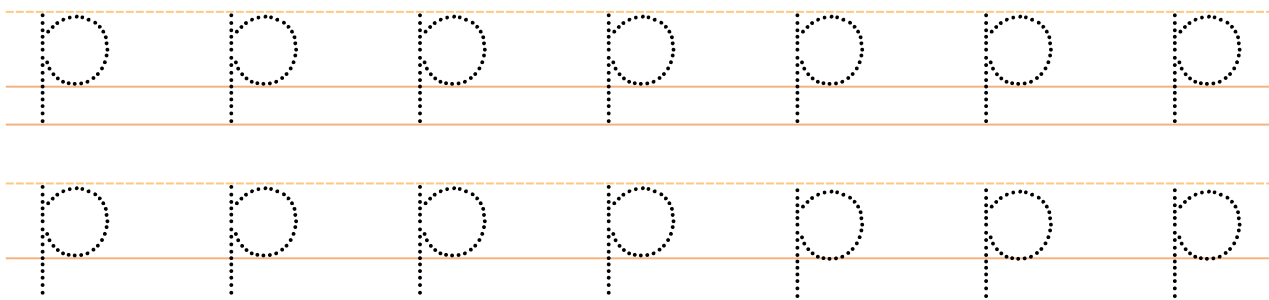

Circle the letter P & p.

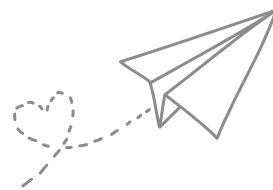
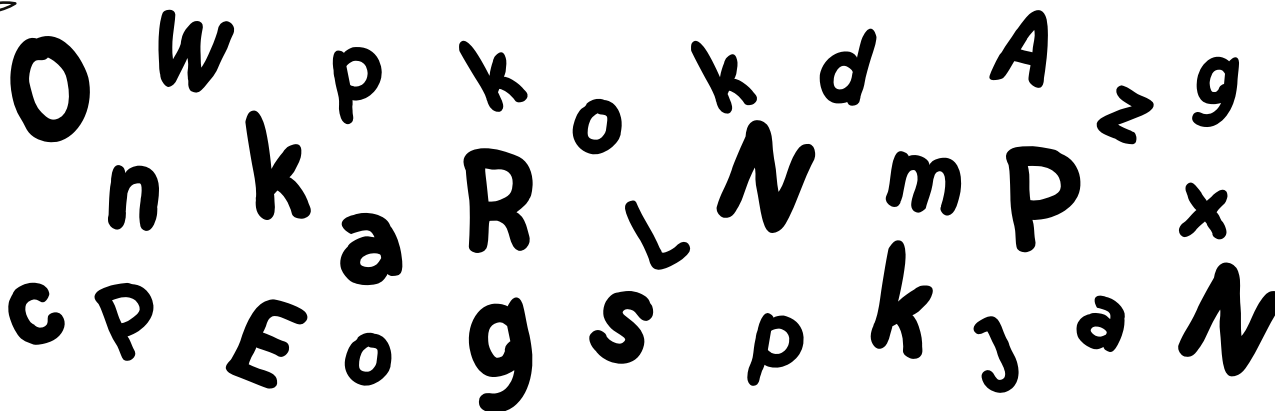

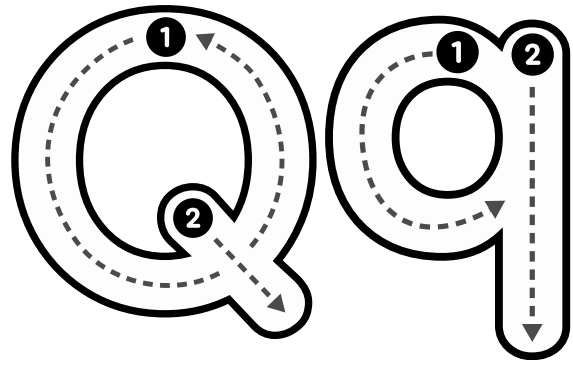
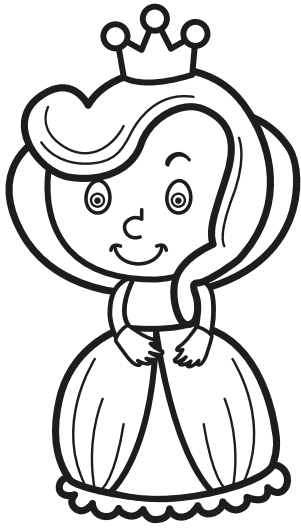

is for Queen



Trace the uppercase letters.

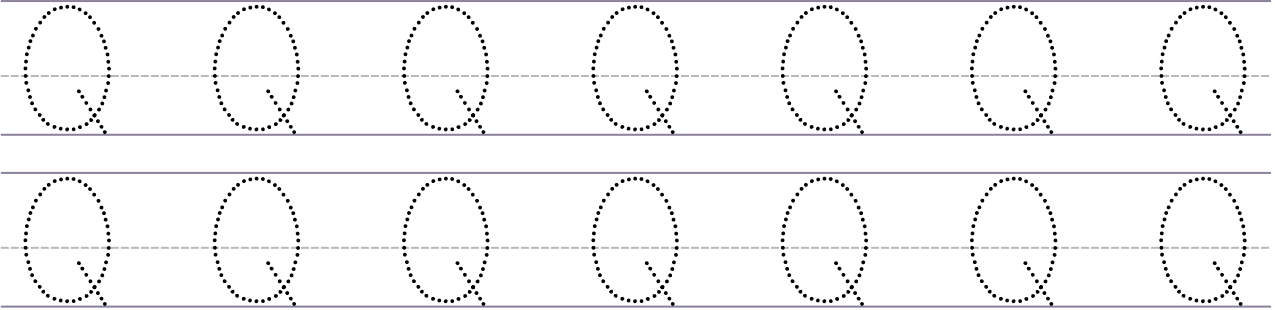

Trace the lowercase letters.

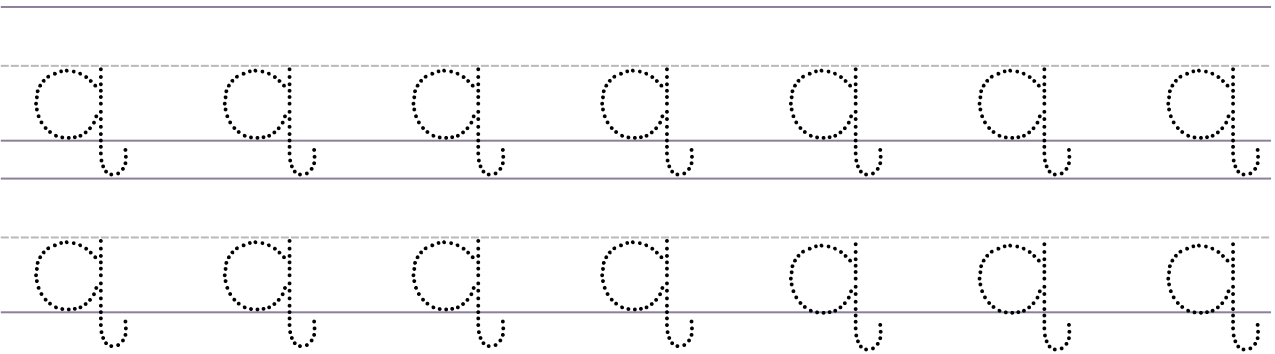

Circle the letter Q & q.

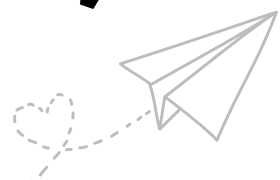
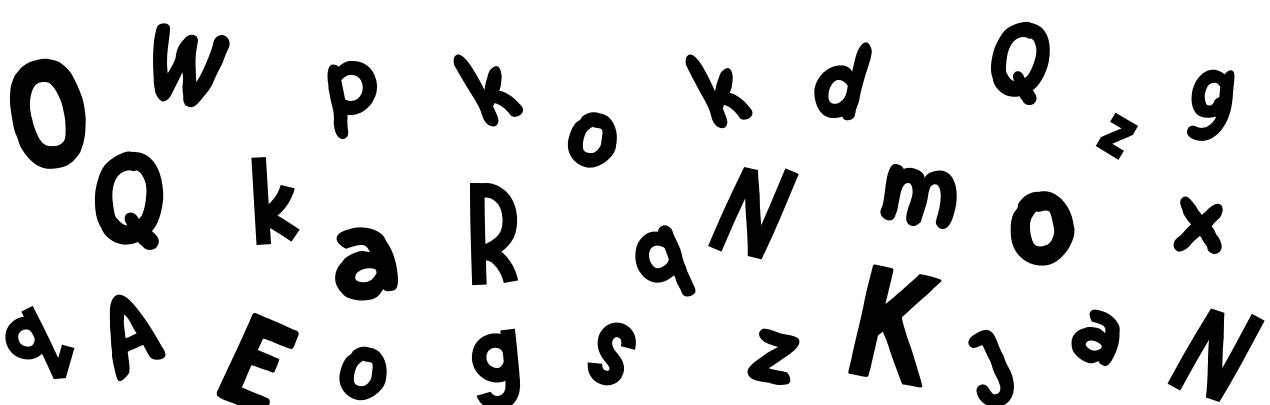

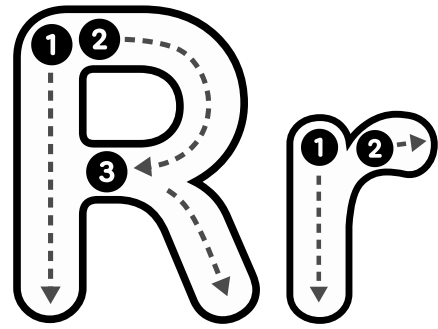

is for Rat



Trace the uppercase letters.

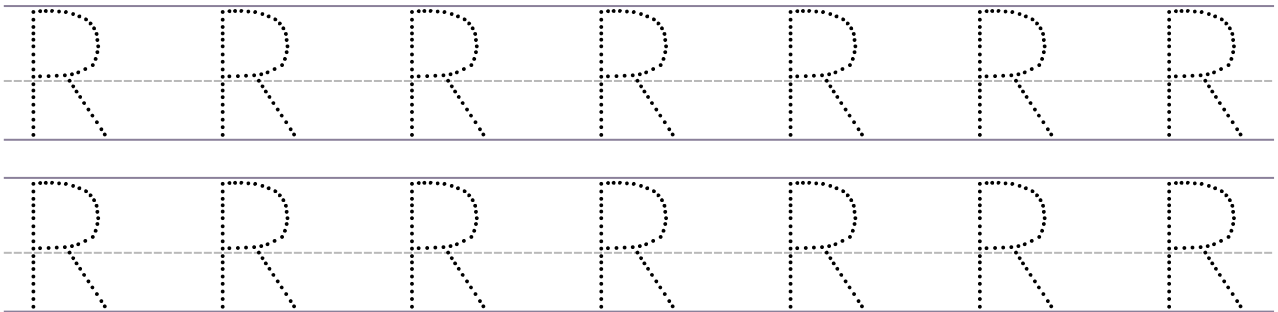

Trace the lowercase letters.

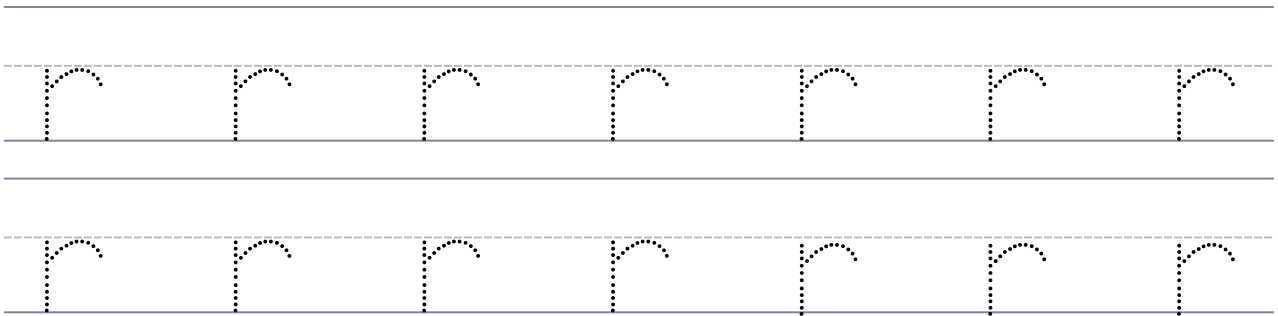

Circle the letter R & r.

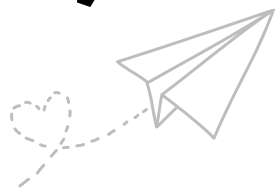
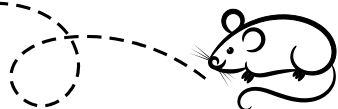
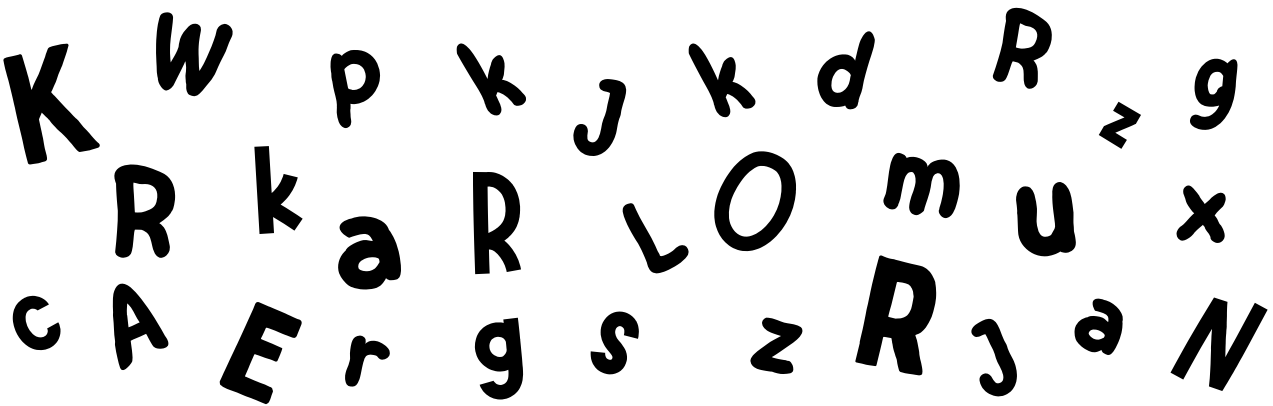
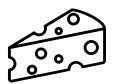

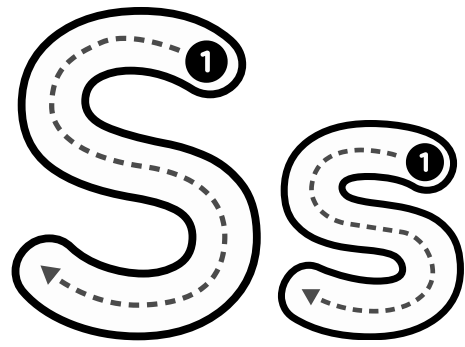
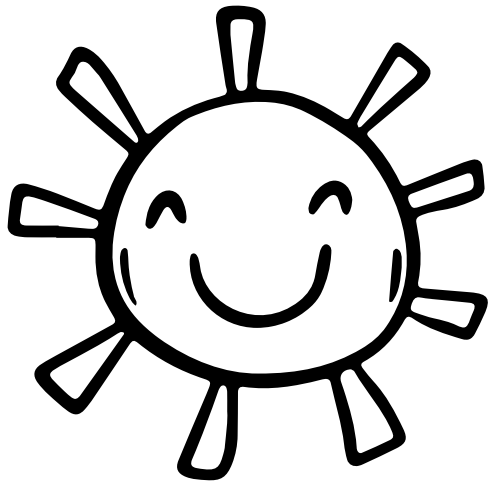

is for Sun



Trace the uppercase letters.

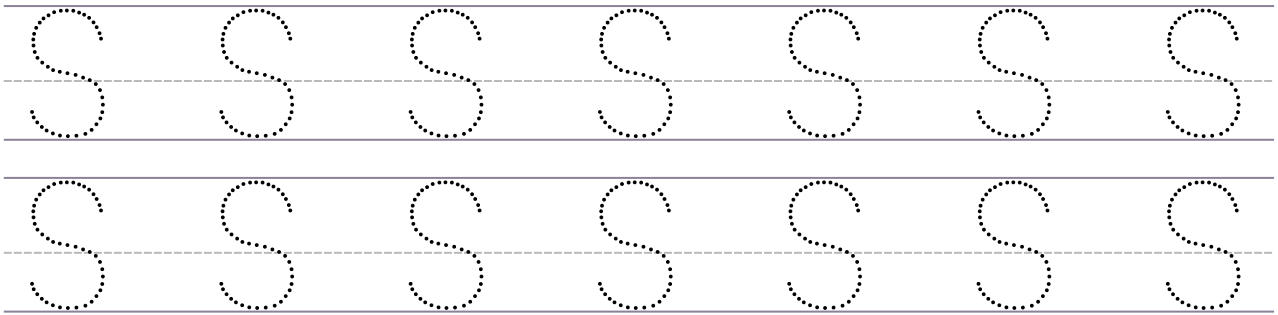

Trace the lowercase letters.

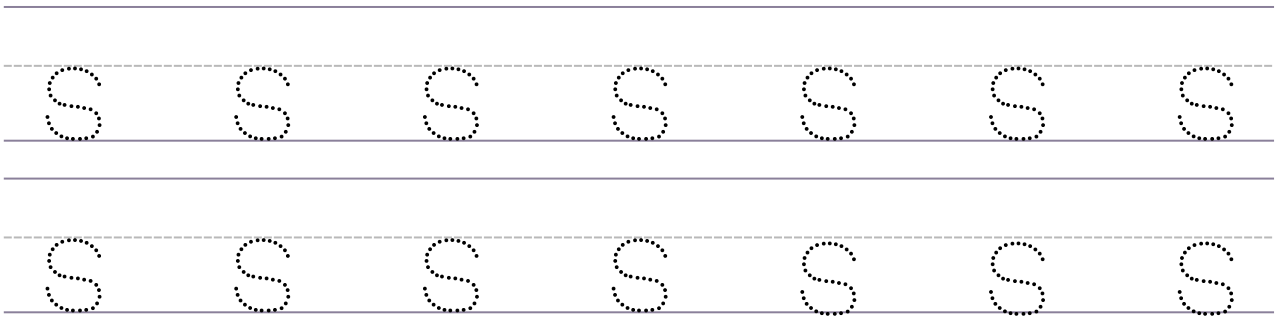

Circle the letter S & s.



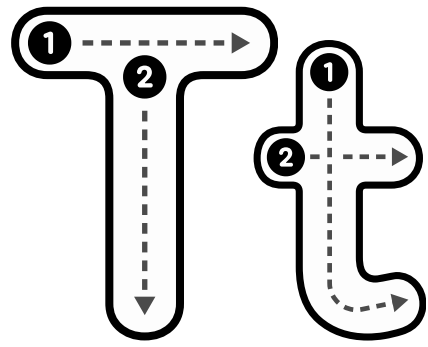
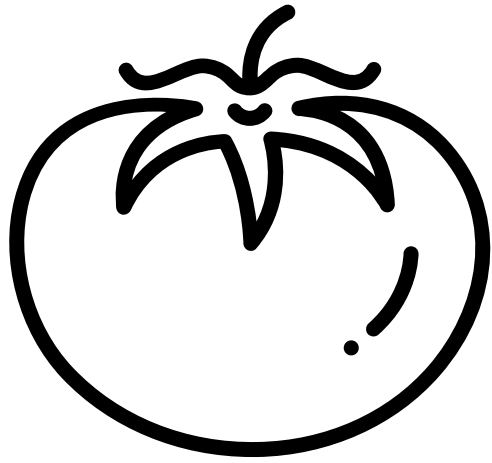

is for Tomato



Trace the uppercase letters.

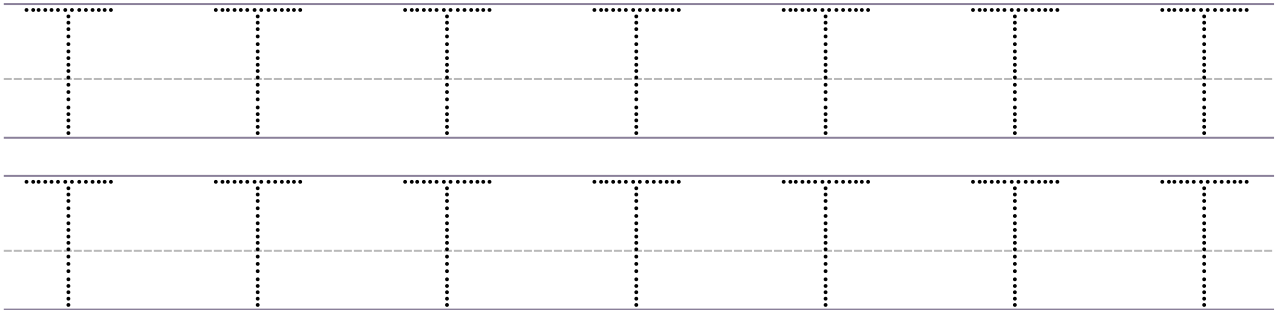

Trace the lowercase letters.



Circle the letter T & t.

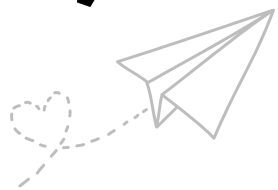
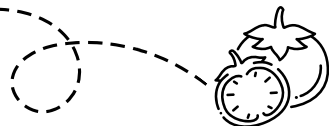
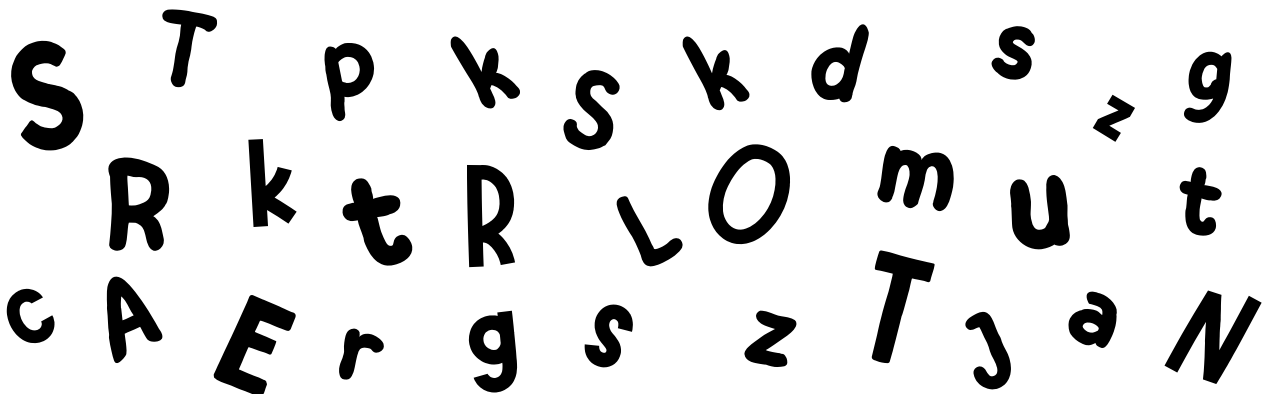

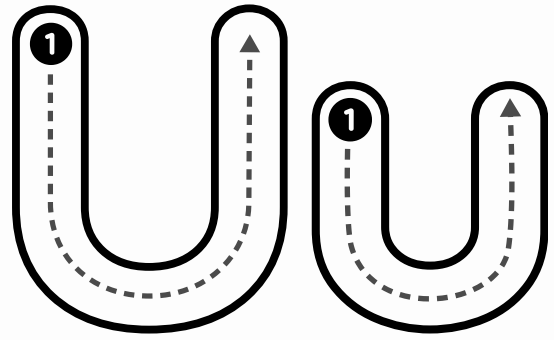
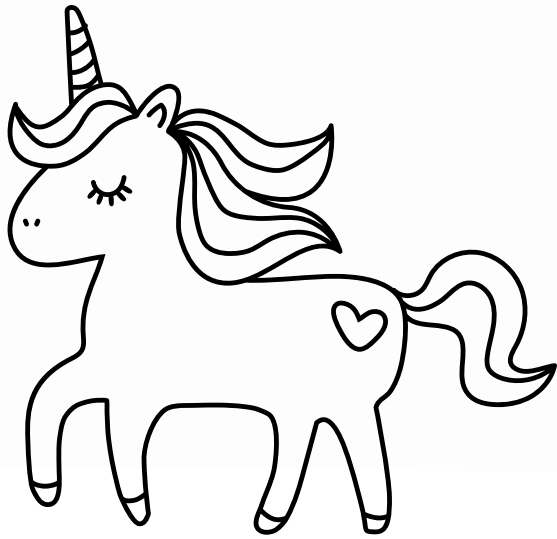

is for Unicorn



Trace the uppercase letters.

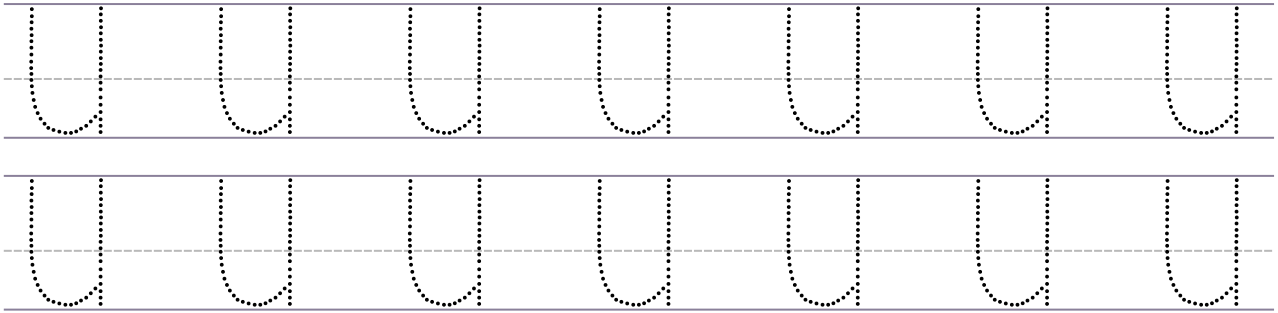

Trace the lowercase letters.

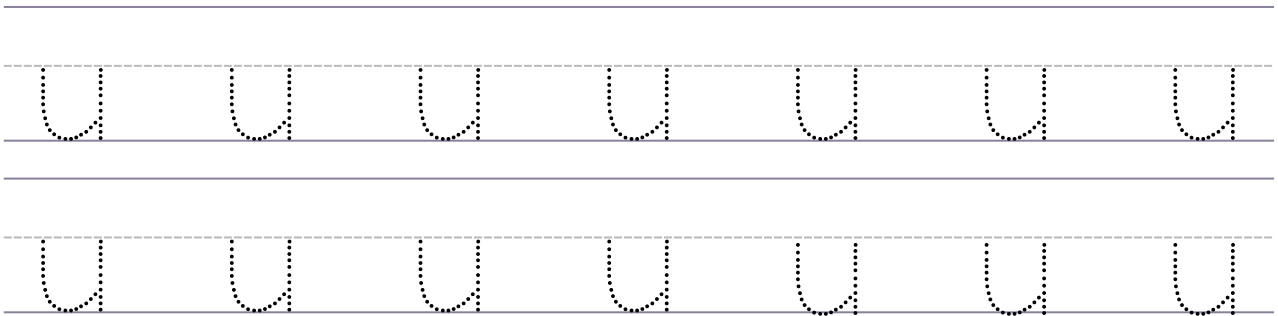

Circle the letter U & u.

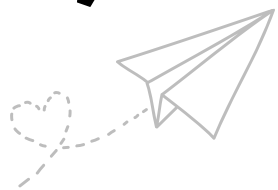
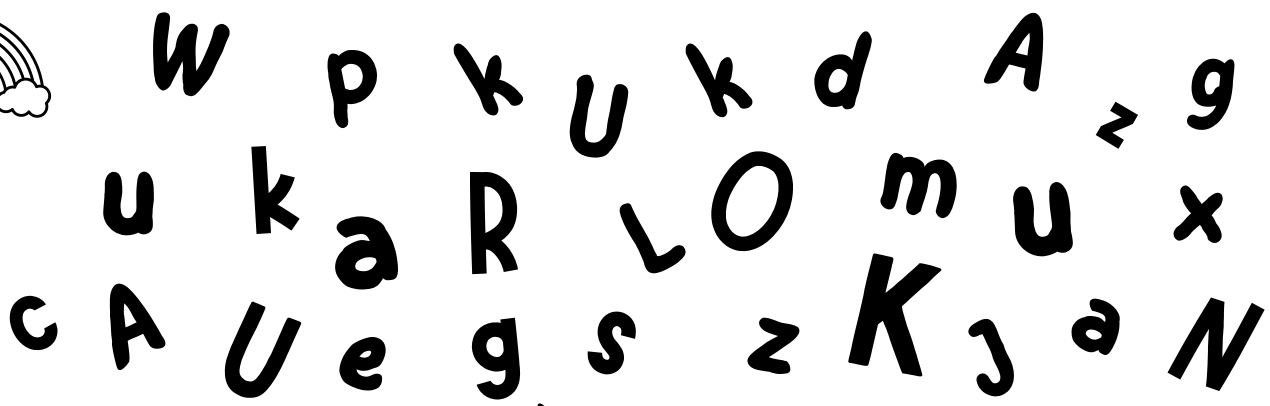

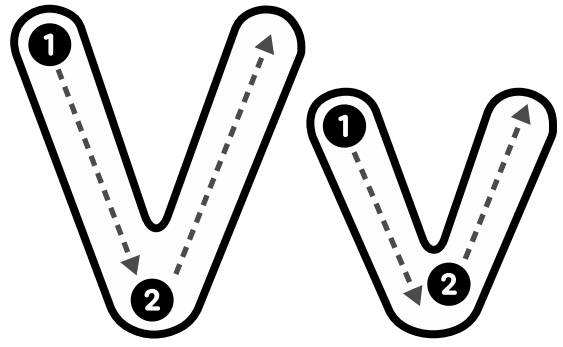

is for Violin



Trace the uppercase letters.

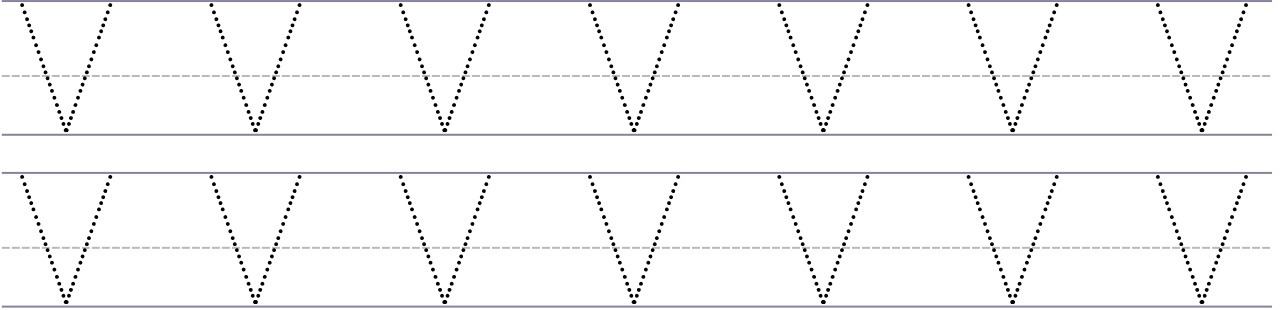

Trace the lowercase letters.

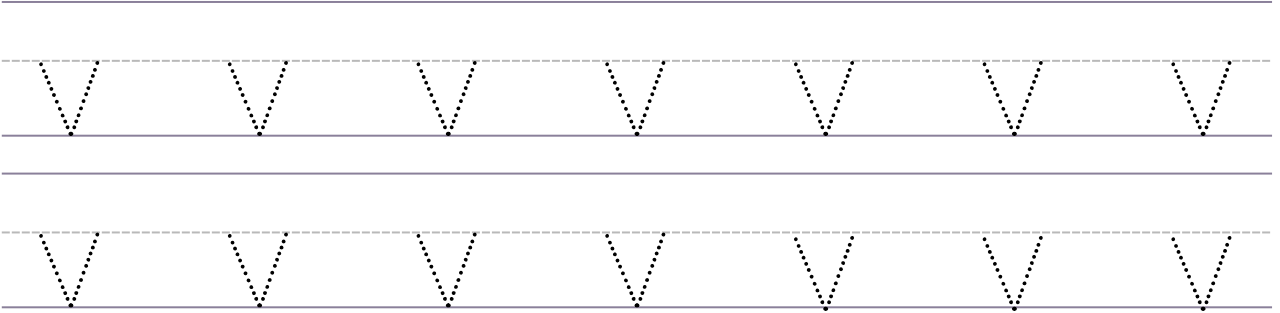

Circle the letter V & v.

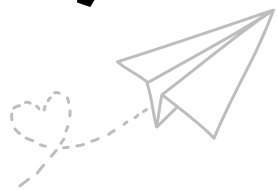
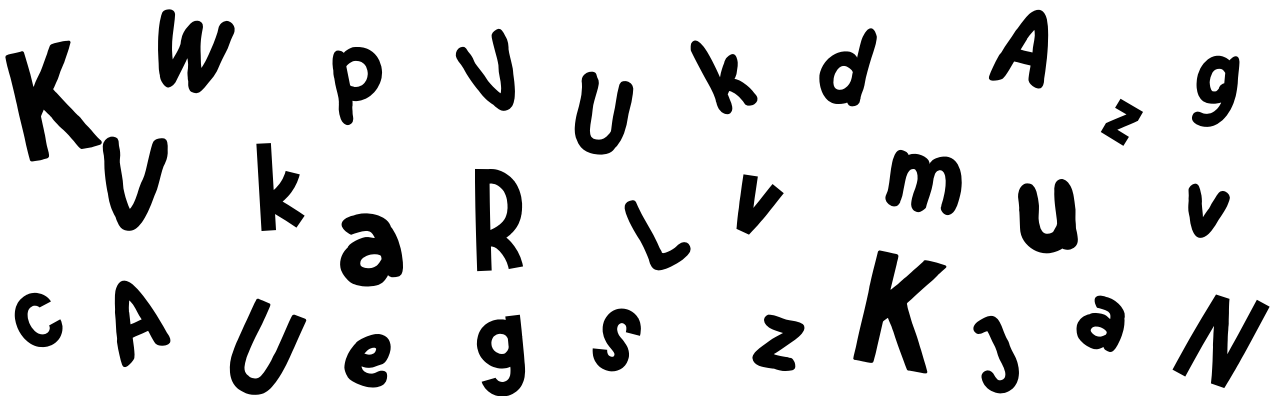

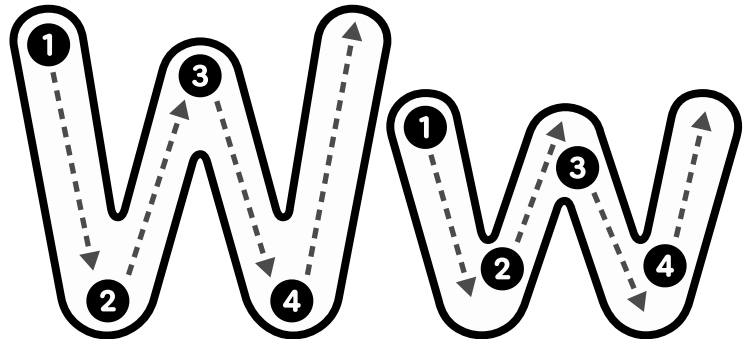

is for Wizard



Trace the uppercase letters.

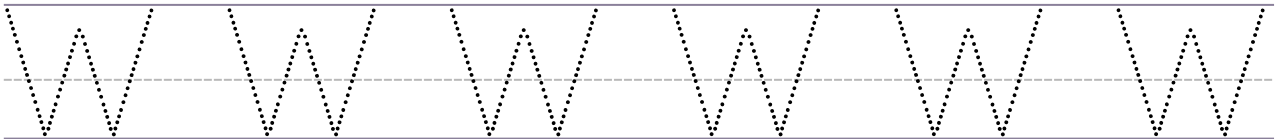
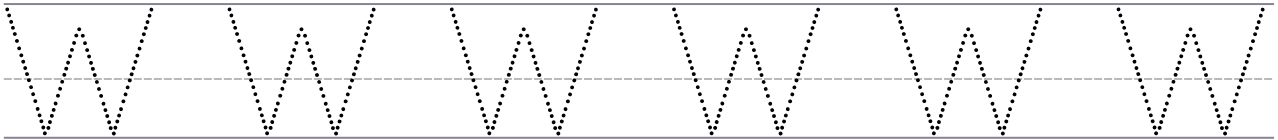

Trace the lowercase letters.



Circle the letter W & w.

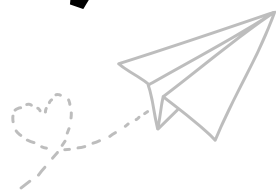
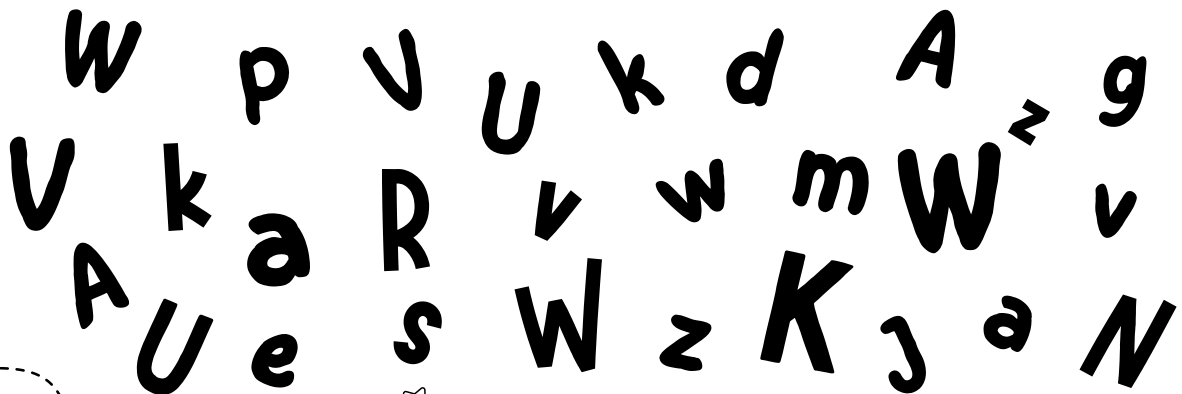

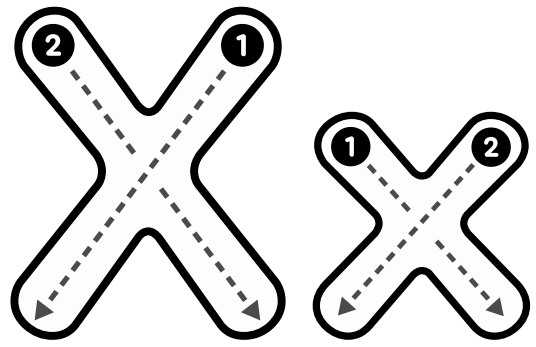
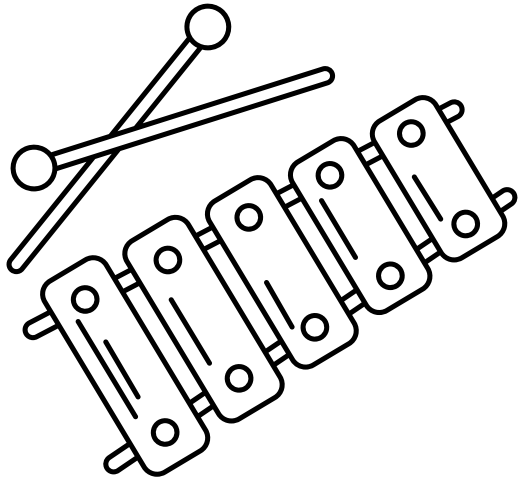

is for Xylophone



Trace the uppercase letters.

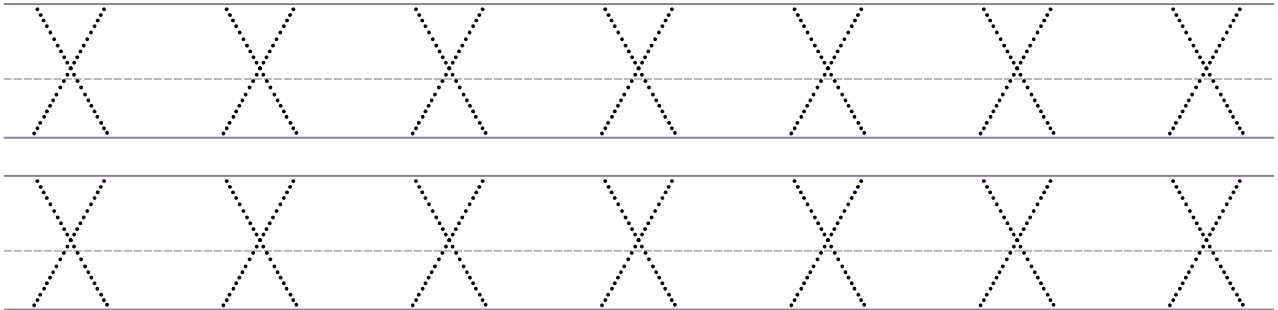

Trace the lowercase letters.

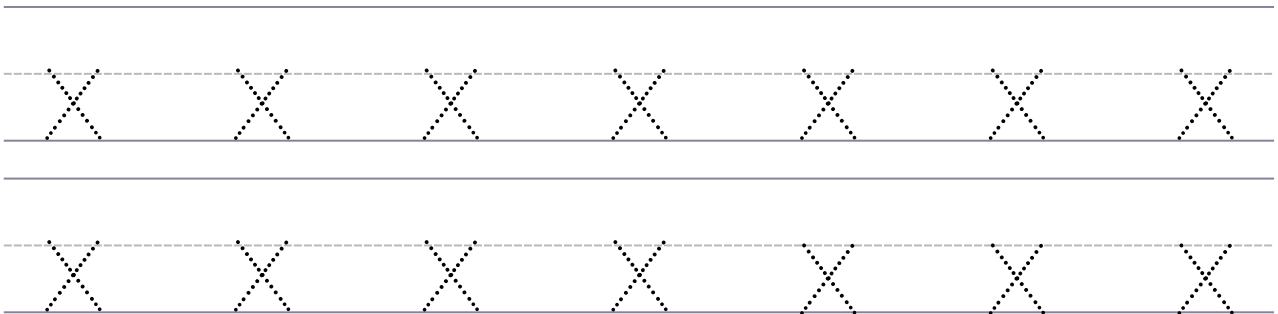

Circle the letter X & x.

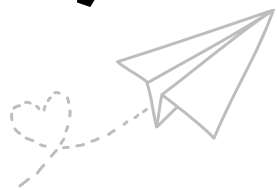
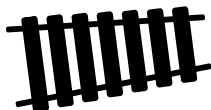
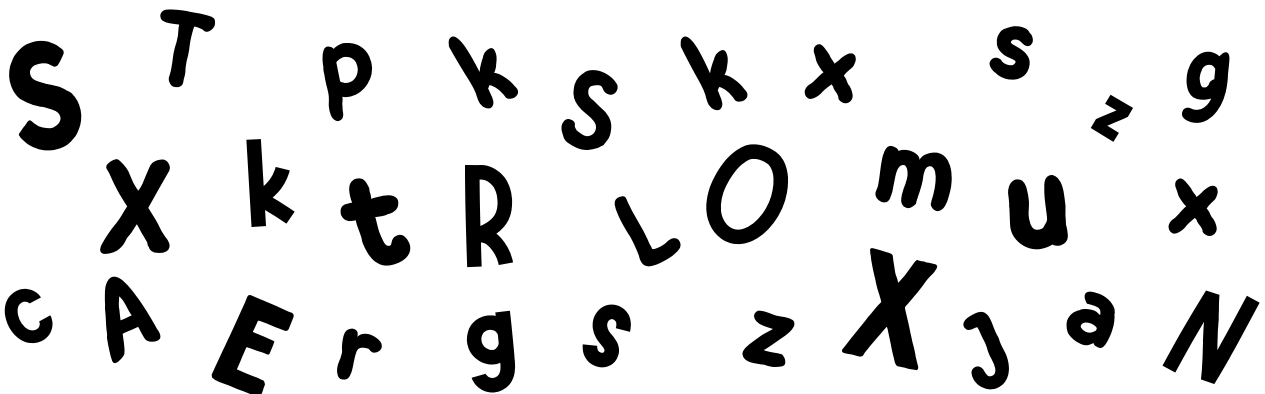

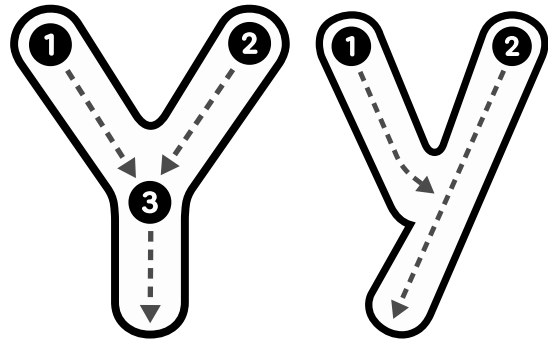
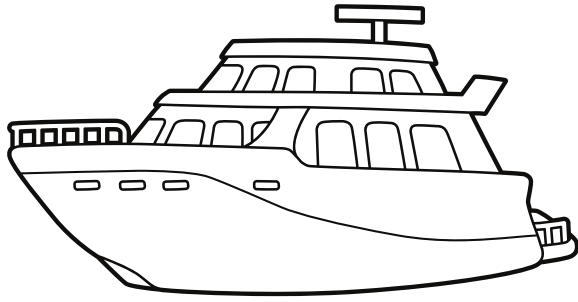

is for Yacht



Trace the uppercase letters.

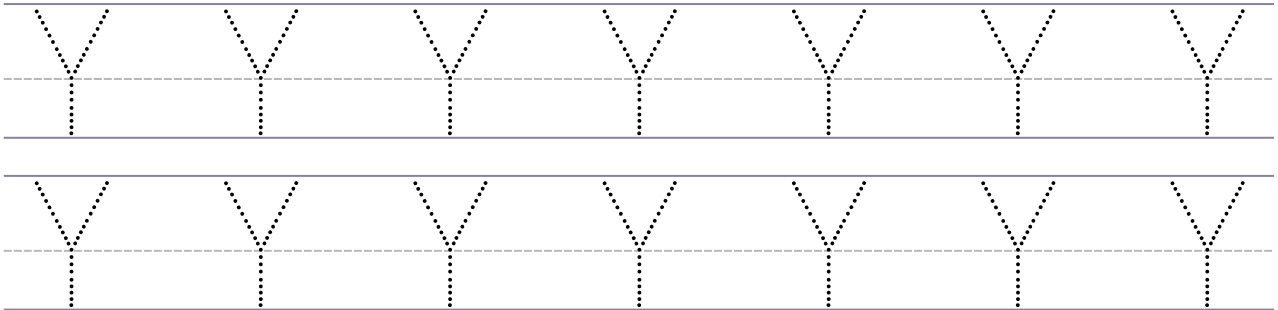

Trace the lowercase letters.

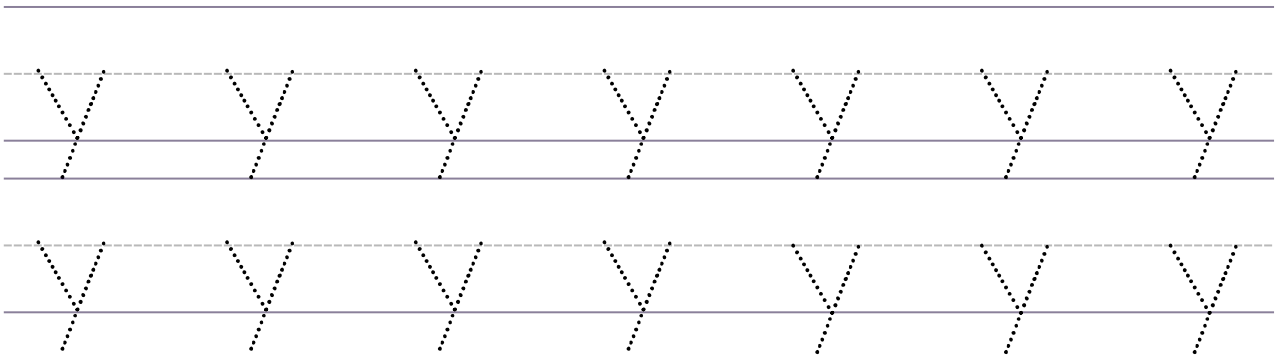

Circle the letter Y & y.

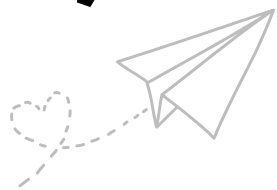
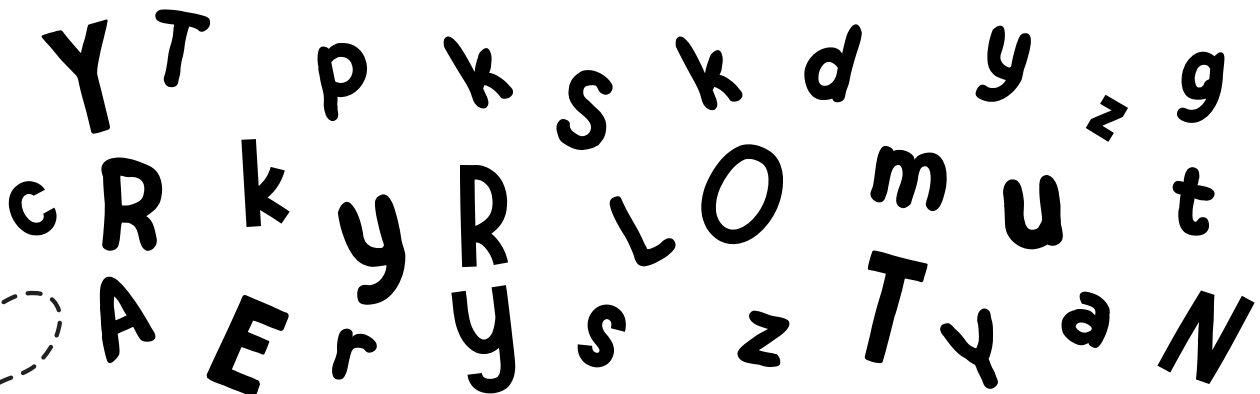

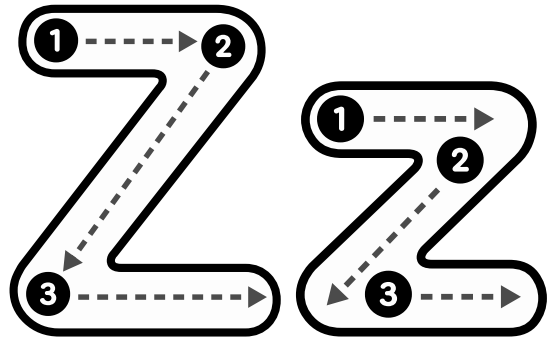

is for Zebra

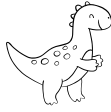

Trace the uppercase letters.

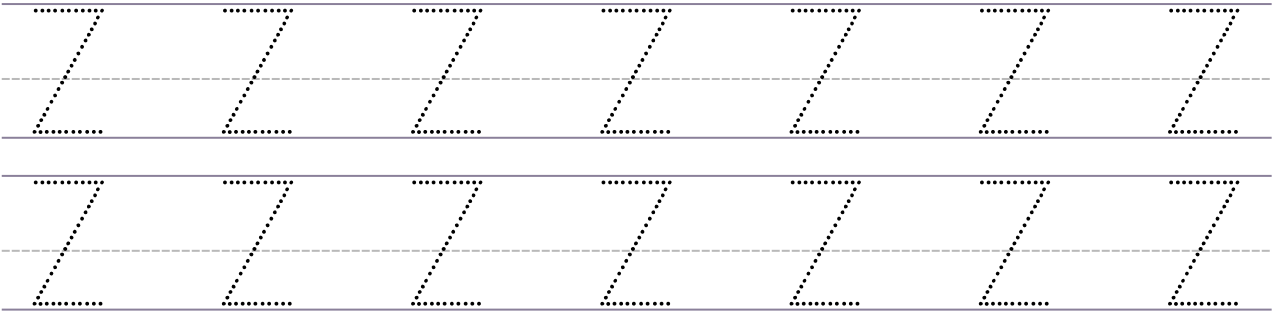

Trace the lowercase letters.

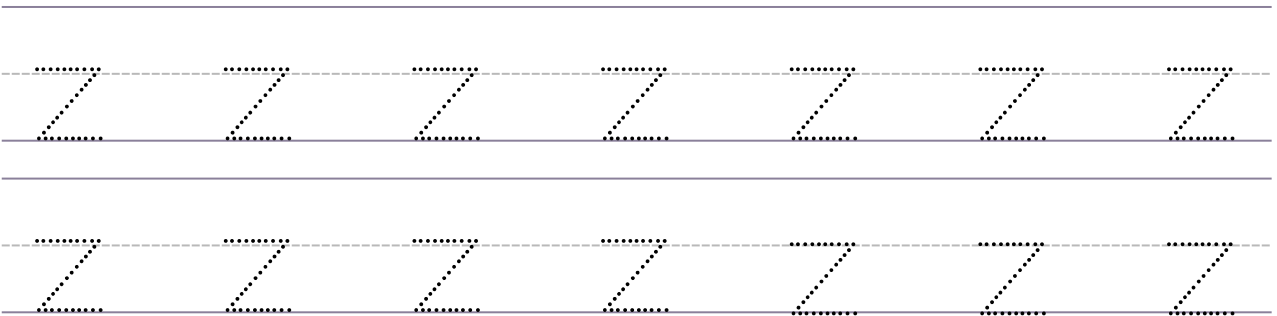

Circle the letter Z & z.

